

**SC SERIES ENCLOSURES
NEMA 1 SCREW COVER WALL-MOUNT**



SC060604
with SCF cover



SC080806G



SC080806NK

Industry Standards

UL 50, Type 1
CSA Certified, Type 1 (See Note)
NEMA/EEMAC Type 1

UL Files E6924

CSA File LL66078

FEATURES-SPECIFICATIONS

Applications

Designed for use as a junction box and pull box in commercial and general industrial applications. Flush covers must be ordered separately for flush mount applications.

Construction

- Fabricated from 16, 14 and 12 gauge steel or G-90 pre-galvanized steel (reference table)
- Flat, removable covers fastened with plated steel screws

- Cover design permits easy removal without extracting cover screws
- Mounting holes on back of box
- Available with or without knockouts. Removable concentric knockouts on all four sides of standard enclosures with knockouts

Finish

- ANSI-61 gray polyester powder inside and out over phosphatized surfaces
- Unpainted pre-galvanized steel

Accessories

- See pages J1-J19

Optional Flush Covers

Designed to mount on enclosure for flush installations. 16 or 14 gauge steel (reference table).

- ANSI 61 gray polyester powder finish.
- Unpainted pre-galvanized steel

SC SERIES SCREW COVER PULL BOX ENCLOSURES								
CATALOG NUMBER				BODY/DOOR STEEL GAUGE	FLUSH COVER AVAILABLE (SEE PG. A5)	ENCLOSURE SIZE H+1/8", W+1/8", D+3/16"	KNOCKOUT PATTERN	
PAINTED		GALVANIZED					WIDTH SIDE	HEIGHT SIDE
W/KNOCKOUTS	W/O KNOCKOUTS	W/KNOCKOUTS	W/O KNOCKOUTS					
SC040404*	SC040404NK*	SC040404G*	SC040404GNK*	16/16	Yes	4.00x4.00x4.00 (102x102x102)	A	A
SC040604*	SC040604NK*	SC040604G*	SC040604GNK*	16/16	Yes	6.00x4.00x4.00 (152x102x102)	A	A-B-A
SC060604	SC060604NK	SC060604G	SC060604GNK	16/16	Yes	6.00x6.00x4.00 (152x152x102)	A-B-A	A-B-A
SC060804	SC060804NK	SC060804G	SC060804GNK	16/16	Yes	8.00x6.00x4.00 (203x152x102)	A-B-A	A-B-A
SC061204	SC061204NK	SC061204G	SC061204GNK	16/16	Yes	12.00x6.00x4.00 (305x152x102)	A-B-A	B-A-F-F-A-B
SC080804	SC080804NK	SC080804G	SC080804GNK	16/16	Yes	8.00x8.00x4.00 (203x203x102)	A-B-A	A-B-A
SC081004	SC081004NK	SC081004G	SC081004GNK	16/16	Yes	10.00x8.00x4.00 (254x203x102)	A-B-A	B-A-F-F-A
SC081204	SC081204NK	SC081204G	SC081204GNK	16/16	Yes	12.00x8.00x4.00 (305x203x102)	A-B-A	B-A-F-F-A-B
SC101004	SC101004NK	SC101004G	SC101004GNK	16/16	Yes	10.00x10.00x4.00 (254x254x102)	B-A-F-F-A	B-A-F-F-A
SC101204	SC101204NK	SC101204G	SC101204GNK	16/16	Yes	12.00x10.00x4.00 (305x254x102)	B-A-F-F-A	B-A-F-F-A-B
SC121204	SC121204NK	SC121204G	SC121204GNK	16/16	Yes	12.00x12.00x4.00 (305x305x102)	B-A-F-F-A-B	B-A-F-F-A-B
SC121504	SC121504NK	SC121504G	SC121504GNK	16/16	Yes	15.00x12.00x4.00 (381x305x102)	B-A-F-F-A-B	A-B-A-F-F-A-B-A

(+) All products, unless otherwise denoted by a (+), are: H+1/8", W+1/8", D+3/16"

Continued on page A3



SC SERIES SCREW COVER PULL BOX ENCLOSURES (CONT.)								
CATALOG NUMBER				BODY/DOOR STEEL GAUGE	FLUSH COVER AVAILABLE (SEE PG. A5)	ENCLOSURE SIZE H+ ¹ / ₈ " , W+ ¹ / ₈ " , D+ ³ / ₁₆ "	KNOCKOUT PATTERN	
PAINTED		GALVANIZED					WIDTH SIDE	HEIGHT SIDE
W/KNOCKOUTS	W/O KNOCKOUTS	W/KNOCKOUTS	W/O KNOCKOUTS					
SC121804	SC121804NK	SC121804G	SC121804GNK	16/16	Yes	18.00x12.00x4.00 (457x305x102)	B-A-F-F-A-B	A-B-A-F-F-A-B-A
SC122404	SC122404NK	SC122404G	SC122404GNK	16/16	Yes	24.00x12.00x4.00 (610x305x102)	B-A-F-F-A-B	A-B-A-F-F-A-B-A
SC151504	SC151504NK	SC151504G	SC151504GNK	16/16	Yes	15.00x15.00x4.00 (381x381x102)	A-B-A-F-F-A-B-A	A-B-A-F-F-A-B-A
SC151804	SC151804NK	SC151804G	SC151804GNK	16/16	Yes	18.00x15.00x4.00 (457x381x102)	A-B-A-F-F-A-B-A	A-B-A-F-F-A-B-A
SC181804	SC181804NK	SC181804G	SC181804GNK	16/16	Yes	18.00x18.00x4.00 (457x457x102)	A-B-A-F-F-A-B-A	A-B-A-F-F-A-B-A
SC182404	SC182404NK	SC182404G	SC182404GNK	16/16	Yes	24.00x18.00x4.00 (610x457x102)	A-B-A-F-F-A-B-A	A-B-A-F-F-A-B-A
SC183004	SC183004NK	SC183004G	SC183004GNK	16/16	Yes	30.00x18.00x4.00 (762x457x102)	A-B-A-F-F-A-B-A	A-B-A-F-F-A-B-A
SC242404	SC242404NK	SC242404G	SC242404GNK	14/14	Yes	24.00x24.00x4.00 (610x610x102)	A-B-A-F-F-A-B-A	A-B-A-F-F-A-B-A
SC060606	SC060606NK	SC060606G	SC060606GNK	16/16	Yes	6.00x6.00x6.00 (152x152x152)	A-B-A	A-B-A
SC060806	SC060806NK	SC060806G	SC060806GNK	16/16	Yes	8.00x6.00x6.00 (203x152x152)	A-B-A	A-B-A
SC061206	SC061206NK	SC061206G	SC061206GNK	16/16	Yes	12.00x6.00x6.00 (305x152x152)	A-B-A	B-A-F-F-A-B
SC080806	SC080806NK	SC080806G	SC080806GNK	16/16	Yes	8.00x8.00x6.00 (203x203x152)	A-B-A	A-B-A
SC081006	SC081006NK	SC081006G	SC081006GNK	16/16	Yes	10.00x8.00x6.00 (254x203x152)	A-B-A	B-A-F-F-A
SC081206	SC081206NK	SC081206G	SC081206GNK	16/16	Yes	12.00x8.00x6.00 (305x203x152)	A-B-A	B-A-F-F-A-B
SC101006	SC101006NK	SC101006G	SC101006GNK	16/16	Yes	10.00x10.00x6.00 (254x254x152)	B-A-F-F-A	B-A-F-F-A
SC101206	SC101206NK	SC101206G	SC101206GNK	16/16	Yes	12.00x10.00x6.00 (305x254x152)	B-A-F-F-A	B-A-F-F-A-B
SC121206	SC121206NK	SC121206G	SC121206GNK	16/16	Yes	12.00x12.00x6.00 (305x305x152)	B-A-F-F-A-B	B-A-F-F-A-B
SC121506	SC121506NK	SC121506G	SC121506GNK	16/16	Yes	15.00x12.00x6.00 (381x305x152)	B-A-F-F-A-B	A-B-A-F-F-A-B-A
SC121806	SC121806NK	SC121806G	SC121806GNK	16/16	Yes	18.00x12.00x6.00 (457x305x152)	B-A-F-F-A-B	A-B-A-F-F-A-B-A
SC122406	SC122406NK	SC122406G	SC122406GNK	16/16	Yes	24.00x12.00x6.00 (610x305x152)	B-A-F-F-A-B	A-B-A-F-F-A-B-A

*Not UL Listed.

Continued on page A4

Note: Must specify CSA Label when ordering.
Consult factory for dimensions and drawings on 8", 10" and 12" deep enclosures.

Note: 8", 10" and 12" deep enclosures do not have mounting embosses in back of enclosure, only mounting holes.

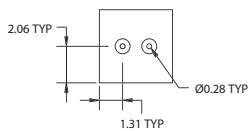

4.00" X 4.00" MOUNTING

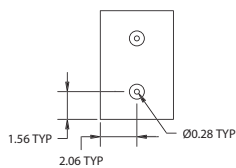

4.00" X 6.00" MOUNTING

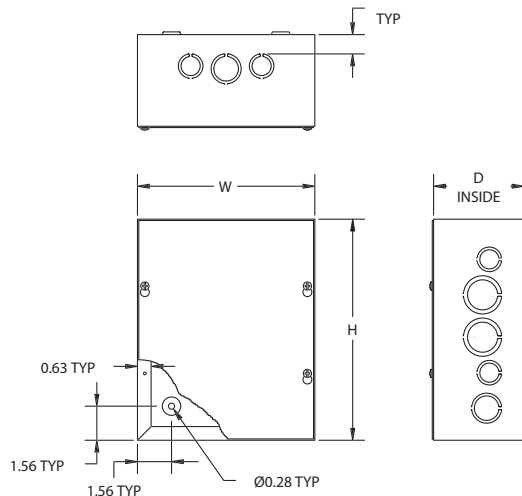

4" SIDE

Knockout Patterns

A -- 1/2" TO 3/4"
B -- 3/4" TO 1"
F -- 1" TO 1-1/4"

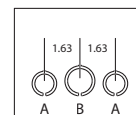

6" & 8" SIDE

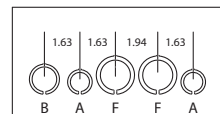

10" SIDE

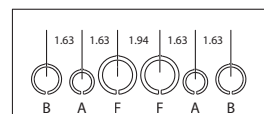

12" SIDE

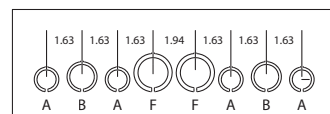

15", 18", 24",
30" & 36" SIDE.

**SC SERIES ENCLOSURES
NEMA 1 SCREW COVER WALL-MOUNT**

SC SERIES SCREW COVER PULL BOX ENCLOSURES (CONT.)								
CATALOG NUMBER				BODY/DOOR STEEL GAUGE	FLUSH COVER AVAILABLE (SEE PG. A5)	ENCLOSURE SIZE H+1/8", W+1/8", D+3/16"	KNOCKOUT PATTERN	
PAINTED		GALVANIZED					WIDTH SIDE	HEIGHT SIDE
W/KNOCKOUTS	W/O KNOCKOUTS	W/KNOCKOUTS	W/O KNOCKOUTS					
SC151506	SC151506NK	SC151506G	SC151506GNK	16/16	Yes	15.00x15.00x6.00 (381x381x152)	A-B-A-F-F-A-B-A	A-B-A-F-F-A-B-A
SC151806	SC151806NK	SC151806G	SC151806GNK	16/16	Yes	18.00x15.00x6.00 (457x381x152)	A-B-A-F-F-A-B-A	A-B-A-F-F-A-B-A
SC181806	SC181806NK	SC181806G	SC181806GNK	16/16	Yes	18.00x18.00x6.00 (457x457x152)	A-B-A-F-F-A-B-A	A-B-A-F-F-A-B-A
SC182406	SC182406NK	SC182406G	SC182406GNK	16/16	Yes	24.00x18.00x6.00 (610x457x152)	A-B-A-F-F-A-B-A	A-B-A-F-F-A-B-A
SC242406	SC242406NK	SC242406G	SC242406GNK	14/14	Yes	24.00x24.00x6.00 (610x610x152)	A-B-A-F-F-A-B-A	A-B-A-F-F-A-B-A
SC243006	SC243006NK	SC243006G	SC243006GNK	14/14	No	30.00x24.00x6.00 (762x610x152)	A-B-A-F-F-A-B-A	A-B-A-F-F-A-B-A
+SC080808	+SC080808NK	+SC080808G	+SC080808GNK	16/16	Yes	8.00x8.00x8.00 (203x203x203)	A-B-A	A-B-A
+SC121208	+SC121208NK	+SC121208G	+SC121208GNK	16/16	Yes	12.00x12.00x8.00 (305x305x203)	B-A-F-F-A-B	B-A-F-F-A-B
+SC121608	+SC121608NK	+SC121608G	+SC121608GNK	16/16	No	16.00x12.00x8.00 (406x305x203)	B-A-F-F-A-B	A-B-A-F-F-A-B-A
+SC121808	+SC121808NK	+SC121808G	+SC121808GNK	16/16	Yes	18.00x12.00x8.00 (457x305x203)	B-A-F-F-A-B	A-B-A-F-F-A-B-A
+SC122408	+SC122408NK	+SC122408G	+SC122408GNK	16/16	Yes	24.00x12.00x8.00 (610x305x203)	B-A-F-F-A-B	A-B-A-F-F-A-B-A
+SC181808	+SC181808NK	+SC181808G	+SC181808GNK	16/16	Yes	18.00x18.00x8.00 (457x457x203)	A-B-A-F-F-A-B-A	A-B-A-F-F-A-B-A
+SC182408	+SC182408NK	+SC182408G	+SC182408GNK	16/16	Yes	24.00x18.00x8.00 (610x457x203)	A-B-A-F-F-A-B-A	A-B-A-F-F-A-B-A
+SC242408	+SC242408NK	+SC242408G	+SC242408GNK	14/14	Yes	24.00x24.00x8.00 (610x610x203)	A-B-A-F-F-A-B-A	A-B-A-F-F-A-B-A
+SC243008	+SC243008NK	+SC243008G	+SC243008GNK	14/14	No	30.00x24.00x8.00 (762x610x203)	A-B-A-F-F-A-B-A	A-B-A-F-F-A-B-A
+SC243608	+SC243608NK	+SC243608G	+SC243608GNK	14/14	No	36.00x24.00x8.00 (914x610x203)	A-B-A-F-F-A-B-A	A-B-A-F-F-A-B-A
—	+SC303008NK	—	+SC303008GNK	12/12	No	30.00x30.00x8.00 (762x762x203)	A-B-A-F-F-A-B-A	A-B-A-F-F-A-B-A
—	+SC303608NK	—	+SC303608GNK	12/12	No	36.00x30.00x8.00 (914x762x203)	A-B-A-F-F-A-B-A	A-B-A-F-F-A-B-A
—	+SC363608NK	—	+SC363608GNK	12/12	No	36.00x36.00x8.00 (914x914x203)	A-B-A-F-F-A-B-A	A-B-A-F-F-A-B-A
+SC121210	+SC121210NK	+SC121210G	+SC121210GNK	16/16	Yes	12.00x12.00x10.00 (305x305x254)	B-A-F-F-A-B	B-A-F-F-A-B
+SC121810	+SC121810NK	+SC121810G	+SC121810GNK	16/16	Yes	18.00x12.00x10.00 (457x305x254)	B-A-F-F-A-B	A-B-A-F-F-A-B-A
+SC122410	+SC122410NK	+SC122410G	+SC122410GNK	16/16	Yes	24.00x12.00x10.00 (610x305x254)	B-A-F-F-A-B	A-B-A-F-F-A-B-A
+SC181810	+SC181810NK	+SC181810G	+SC181810GNK	16/16	Yes	18.00x18.00x10.00 (457x457x254)	A-B-A-F-F-A-B-A	A-B-A-F-F-A-B-A
+SC182410	+SC182410NK	+SC182410G	+SC182410GNK	16/16	Yes	24.00x18.00x10.00 (610x457x254)	A-B-A-F-F-A-B-A	A-B-A-F-F-A-B-A
+SC242410	+SC242410NK	+SC242410G	+SC242410GNK	14/14	Yes	24.00x24.00x10.00 (610x610x254)	A-B-A-F-F-A-B-A	A-B-A-F-F-A-B-A
+SC243010	+SC243010NK	+SC243010G	+SC243010GNK	14/14	No	30.00x24.00x10.00 (762x610x254)	A-B-A-F-F-A-B-A	A-B-A-F-F-A-B-A
—	+SC303010NK	—	+SC303010GNK	12/12	No	30.00x30.00x10.00 (762x762x254)	A-B-A-F-F-A-B-A	A-B-A-F-F-A-B-A
—	+SC303610NK	—	+SC303610GNK	12/12	No	36.00x30.00x10.00 (914x762x254)	A-B-A-F-F-A-B-A	A-B-A-F-F-A-B-A
+SC243610	+SC243610NK	+SC243610G	+SC243610GNK	14/14	No	36.00x24.00x10.00 (914x610x254)	A-B-A-F-F-A-B-A	A-B-A-F-F-A-B-A
—	+SC363610NK	—	+SC363610GNK	12/12	No	36.00x36.00x10.00 (914x914x254)	A-B-A-F-F-A-B-A	A-B-A-F-F-A-B-A
+SC121212	+SC121212NK	+SC121212G	+SC121212GNK	16/16	Yes	12.00x12.00x12.00 (305x305x305)	B-A-F-F-A-B	B-A-F-F-A-B

(+) All products, unless otherwise denoted by a (+), are: H+1/8", W+1/8", D+3/16"

Continued on page A5



SC SERIES SCREW COVER PULL BOX ENCLOSURES (CONT.)								
CATALOG NUMBER				BODY/DOOR STEEL GAUGE	FLUSH COVER AVAILABLE (SEE BELOW)	ENCLOSURE SIZE H x W x D	KNOCKOUT PATTERN	
PAINTED		GALVANIZED					WIDTH SIDE	HEIGHT SIDE
W/KNOCKOUTS	W/O KNOCKOUTS	W/KNOCKOUTS	W/O KNOCKOUTS					
+SC122412	+SC122412NK	+SC122412G	+SC122412GNK	16/16	Yes	24.00x12.00x12.00 (610x305x305)	B-A-F-F-A-B	A-B-A-F-F-A-B-A
+SC181812	+SC181812NK	+SC181812G	+SC181812GNK	16/16	Yes	18.00x18.00x12.00 (457x457x305)	A-B-A-F-F-A-B-A	A-B-A-F-F-A-B-A
+SC182412	+SC182412NK	+SC182412G	+SC182412GNK	16/16	Yes	24.00x18.00x12.00 (610x457x305)	A-B-A-F-F-A-B-A	A-B-A-F-F-A-B-A
+SC242412	+SC242412NK	+SC242412G	+SC242412GNK	14/14	Yes	24.00x24.00x12.00 (610x610x305)	A-B-A-F-F-A-B-A	A-B-A-F-F-A-B-A
+SC243012	+SC243012NK	+SC243012G	+SC243012GNK	14/14	No	30.00x24.00x12.00 (762x610x305)	A-B-A-F-F-A-B-A	A-B-A-F-F-A-B-A
+SC243612	+SC243612NK	+SC243612G	+SC243612GNK	14/14	No	36.00x24.00x12.00 (914x610x305)	A-B-A-F-F-A-B-A	A-B-A-F-F-A-B-A
—	+SC303012NK	—	+SC303012GNK	12/12	No	30.00x30.00x12.00 (762x762x305)	A-B-A-F-F-A-B-A	A-B-A-F-F-A-B-A
—	+SC303612NK	—	+SC303612GNK	12/12	No	36.00x30.00x12.00 (914x762x305)	A-B-A-F-F-A-B-A	A-B-A-F-F-A-B-A
—	+SC363612NK	—	+SC363612GNK	12/12	No	36.00x36.00x12.00 (914x914x305)	A-B-A-F-F-A-B-A	A-B-A-F-F-A-B-A

*Not UL Listed.

Note: Must specify CSA Label when ordering.
Consult factory for dimensions and drawings
on 8", 10" and 12" deep enclosures.

Note: 8", 10" and 12" deep enclosures do not
have mounting embosses in back of enclosure,
only mounting holes.

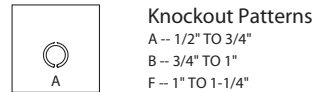

4" SIDE

