

# SAFETY

## IMPORTANT SAFETY INSTRUCTIONS. SAVE THIS INFORMATION.

Follow all safety and assembly instructions when installing Enphase Field Wireable Connectors.

Safety Symbols	
	<b>DANGER:</b> This indicates a hazardous situation, which if not avoided, will result in death or serious injury.
	<b>WARNING:</b> This indicates a situation where failure to follow instructions may be a safety hazard or cause equipment malfunction. Use extreme caution and follow instructions carefully.
	<b>WARNING:</b> Risk of burn. Failure to follow instructions may result in burn injury.
	<b>NOTE:</b> This indicates information particularly important for optimal system operation.

Safety Instructions	
	<b>DANGER:</b> Risk of electric shock. Do not use Enphase equipment in a manner not specified by the manufacturer. Doing so may cause death or injury to persons, or damage to equipment.
	<b>DANGER:</b> Risk of electric shock. Be aware that installation of this equipment includes risk of electric shock. Do not use without first removing AC power from the Enphase System. Disconnect the power coming from the photovoltaics before servicing or installing.
	<b>DANGER:</b> Risk of electric shock. Risk of fire. Before making any connections verify that the circuit breakers are in the off position. Double check all wiring before applying power.
	<b>DANGER:</b> Risk of electric shock. Risk of fire. Only use electrical system components approved for wet locations, including but not limited to conduit fittings.
	<b>DANGER:</b> Risk of electric shock. Risk of fire. Only qualified personnel should install, troubleshoot, or replace the Enphase Field Wireable Connector.
	<b>DANGER:</b> Risk of electric shock. Improper use of the Field Wireable Connector or its components may result in a shock, fire or explosion. To reduce these risks, disconnect all wiring before attempting any maintenance.
	<b>DANGER:</b> Risk of electric shock. Risk of fire. Ensure that all AC and DC wiring is correct and that none of the AC wires are pinched, shorted, or damaged.
	<b>DANGER:</b> Risk of electric shock. Risk of fire. Do not attempt to repair or alter the Enphase Field Wireable Connector.
	<b>DANGER:</b> Risk of electric shock. Risk of fire. Make sure the conductors are not damaged. If the exposed wires are damaged, the system may not function properly.
	<b>WARNING:</b> Risk of equipment damage. Enphase male and female connectors must only be mated with the matching male/female connector.



Safety Instructions	
	<b>WARNING:</b> Risk of equipment damage. This product is intended for operation in an environment having a maximum ambient temperature of 55°C (131°F).
	<b>WARNING:</b> When installing the cabling, secure any loose cable to minimize tripping hazard
	<b>WARNING:</b> Before installing or using the Enphase Field Wireable Connector, read all instructions and cautionary markings in the technical description, on the Enphase System, and on the photovoltaic (PV) equipment.
	<b>NOTE:</b> Using unapproved attachments or accessories may result in damage or injury.
	<b>NOTE:</b> When looping the Enphase Q Cable, do not form loops smaller than 4.75 inches (12 cm) in diameter.
	<b>NOTE:</b> Perform all electrical installations in accordance with all applicable local electrical codes: the Canadian Electrical Code, part 1; the National Electrical Code (NEC); ANSI requirements; and NFPA 70.
	<b>NOTE:</b> To ensure optimal reliability and to meet warranty requirements, install the Enphase Field Wireable Connectors according to the instructions in this guide.
	<b>NOTE:</b> Protection against lightning and resulting voltage surge must be in accordance with local standards.
	<b>NOTE:</b> The connector is considered to be in compliance with UL 6703 only when assembled in the manner specified by these assembly instructions.
	<b>NOTE:</b> Cable used with Enphase Field Wireable connectors must meet the following requirements: <ul style="list-style-type: none"> <li>• Min/max outer insulation diameter (including the clear 2nd insulator): 3.45mm / 3.65mm</li> <li>• Number of conductor strands / size: 19 strands of 0.47 mm</li> <li>• Wire size: 12 AWG</li> </ul>

# PREPARATION

Check that you have Enphase Field Wireable Q Connectors as needed for your installation. Both female and male connectors are sold in packs of ten:

- Field-Wireable Q connector (female): (Q-CONN-10F)
- Field-Wireable Q connector (male): (Q-CONN-10M)

Make sure you have the following required tools:

- Diagonal cutter
- Wire stripper
- Crimp tool: Multi-Contact PV-CZM-18100, -19100, or -22100
- Channel lock pliers or torque wrench
- Enphase disconnect tool



## When to Use Field-Wireable Q Connectors

Use Enphase field-wireable connectors with Enphase Q-Cable or field cable to:

- Easily connect Q cables on the roof without complex wiring
- Use male connectors to make connections from any Q Aggregator open connector
- Use female connectors to make connections from any Q Cable open connector
- Make a jumper to connect with a remote part of the array: Use female to female for cable-to-cable connections, or male to female for aggregator-to-cable extensions
- Use a mated pair of connectors to splice two cut ends of cable

Revision History	
Rev 01	Initial release 02/21/2017.
Rev 02	Revised jacket strip length in step C - 04/10/2017.



# PARTS

## FEMALE CONNECTOR PARTS

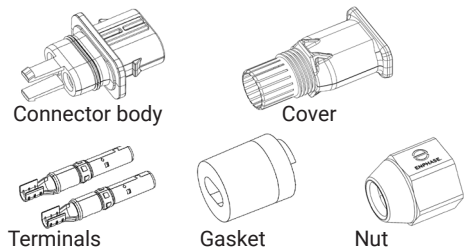

## MALE CONNECTOR PARTS

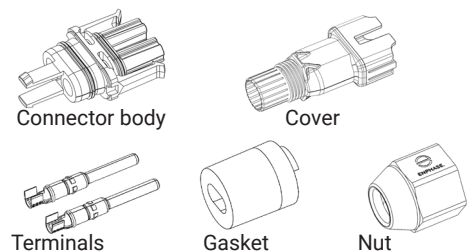

**⚠ WARNING:** Risk of equipment failure. Do not mix male and female connector parts when assembling connectors.

# ASSEMBLY

Follow the steps to assemble Enphase Field-Wireable Connectors.

## FEMALE

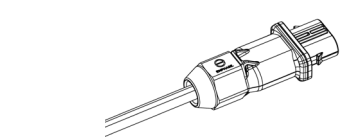
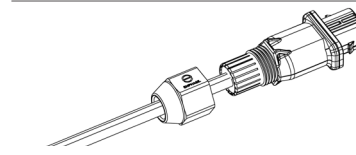
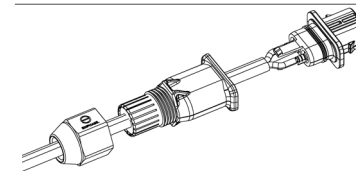
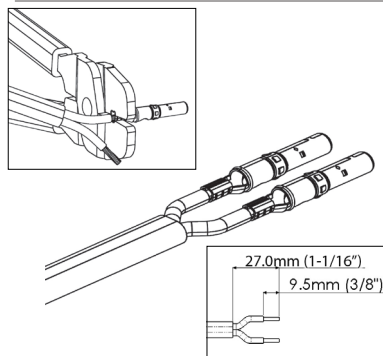
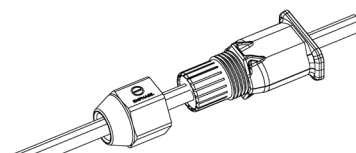
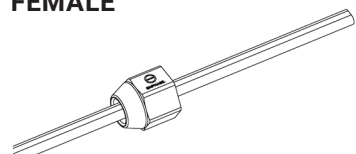

**A)** Take the connector parts out of the bag and do the following:

- Use the nut to mark the cable at 27mm in preparation for step C. The nut is 27mm wide.
- Slide the nut over the cable.

**B)** Make sure the gasket is pre-installed inside the cover, then slide the cover and gasket over the cable.

**C)** Attach the terminals to the cable as follows:

- Strip the outer jacket to 27 mm (1 and 1/16 in.).
- Strip the conductor insulation to 9.5 mm (3/8 in.).
- Load the open end of each terminal in the 12 gauge slot of the crimp tool, flush with the edge of the slot.

**⚠ WARNING:** The jacket must extend completely through the gasket when the body is assembled, and the gasket must fully cover the cable jacket to prevent moisture from entering the connector.

- Crimp the end of the terminal over the stripped wires.
- Do **NOT** crimp over conductor insulation.

**D)** Insert terminals into connector body. Each terminal should click into place.

**E)** Assemble connector body and cover. Listen for a click as they engage.

**F)** Tighten the nut to 7 Nm with channel lock pliers or a torque wrench.

## MALE

