



2017 Specification Guide

Cellwood Brand Products

Cedar Dimensions™ Siding	2 – 5
Vinyl Siding Collection	6 – 11
Cedar Evolutions™	6
Dimensions®	7
Progressions®	8
Evolutions®	10
Colonial Beaded	11
Board & Batten	11
Vinyl Soffit	12 – 18
Hidden Vent	12
Beaded	13
Premium	14
Standard	16
Economy	17
Vinyl Siding & Soffit Accessories	19 – 28
Designer Accents	29 – 56
Mounting Blocks	29
Surface Mounts	33
Vents	36
2-Piece Gable Vents	39
Board & Batten Shutters	43
12" Standard Shutters	47
15" Standard Shutters	49
Standard Shutter Accessories	52
Custom Shutters	53
Window Mantels	54
Door Surround Systems	57
Designer Accents Color Matrix	59 – 80
Aluminum Products	82 – 108
Trim Coil	82
Soffit	97
Fascia	103
Accessories	106
Gutter Protection Systems	109 – 115
Leaf Relief®	109
Leaf Logic®	114
Accessories	115
Roofing Accessories	116 – 124
Steel Siding	125 – 129

Shingle Siding

Product Code: **CEDAR7**

Description	Package
Nominal .100" Thick Length: Double 7"	10 Pcs./Ctn. 1/2 Sqs./Ctn. 40 Lbs./Ctn.



Color Availability

- WHITE** White (04)
- LIGHT** Beige (NB), Pewter (NP), Sand (M4), Sunrise Yellow (IQ), Wicker (A7)
- CLASSIC** French Silk (210), Khaki (N4), Nantucket Gray (N8), Thistle (510)
- DEEP** Canyon (100), Granite (090), Montana Suede (IF), Russet Red (290), Shadow (144), Wedgewood (390), Willow (170)
- SHADED** Shaded Cedar (489), Shaded Gray (490)

Note: Recommended Starter Strip - CPSSHD or CDSS, 3/4" pocket minimum accessories recommended



THIS PRODUCT HAS BEEN GREEN APPROVED BY THE NAHB RESEARCH CENTER.
This means you can be assured that this product complies with specific green practice criteria in the National Green Building Standard. Visit www.GreenApprovedProducts.com for more details.

Shingle Siding Outside Corner Post

Product Code: **CEDAR70CP**

Description	Package
Nominal .100" Thick Length: 28 1/8"	10 Pcs./Ctn. 15.7 Lbs./Ctn. 23-1/3 linear feet per carton

Color Availability

- WHITE** White (04)
- LIGHT** Beige (NB), Pewter (NP), Sand (M4), Sunrise Yellow (IQ), Wicker (A7)
- CLASSIC** French Silk (210), Khaki (N4), Nantucket Gray (N8), Thistle (510)
- DEEP** Canyon (100), Granite (090), Montana Suede (IF), Russet Red (290), Shadow (144), Wedgewood (390), Willow (170)
- SHADED** Shaded Cedar (489), Shaded Gray (490)

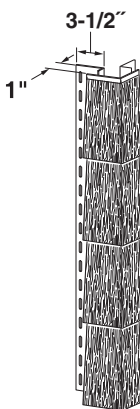

THIS PRODUCT HAS BEEN GREEN APPROVED BY THE NAHB RESEARCH CENTER.
This means you can be assured that this product complies with specific green practice criteria in the National Green Building Standard. Visit www.GreenApprovedProducts.com for more details.

Round Cut Siding

Product Code: **DCHR65**

Description	Package
Nominal .080" Thick Exposure: 48"	12 Pcs./Ctn. 1/2 Sqs./Ctn. 39 Lbs./Ctn.

Color Availability

- WHITE** White (04)
- LIGHT** Sand (M4), Wicker (A7)
- CLASSIC** Khaki (N4), Nantucket Gray (N8)

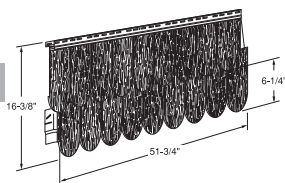

Note: Recommended Starter Strip - CPSSHD or CDSS



THIS PRODUCT HAS BEEN GREEN APPROVED BY THE NAHB RESEARCH CENTER.
This means you can be assured that this product complies with specific green practice criteria in the National Green Building Standard. Visit www.GreenApprovedProducts.com for more details.

Hand Split Shake

Product Code: **CEDAR9**

Description	Package
Length: 58 5/8"	7 Pcs./Ctn.
Height: 20 3/8"	1/2 Sq./Ctn.

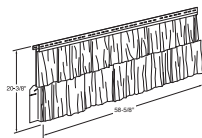

Color Availability

- WHITE** White (04)
- LIGHT** Beige (NB), Pewter (NP), Sand (M4), Sunrise Yellow (IQ), Wicker (A7)
- CLASSIC** French Silk (210), Khaki (N4), Nantucket Gray (N8), Thistle (510)
- DEEP** Canyon (100), Granite (090), Montana Suede (IF), Russet Red (290), Shadow (144), Wedgewood (390), Willow (170)
- SHADED** Shaded Cedar (489), Shaded Gray (490)



THIS PRODUCT HAS BEEN GREEN APPROVED BY THE NABR RESEARCH CENTER.
This means you can be assured that this product complies with specific green practice criteria in the National Green Building Standard. Visit www.GreenApprovedProducts.com for more details.

Hand Split Shake Corner Post

Product Code: **CEDAR90CP**

Description	Package
Length: 38 1/2"	10 Pcs./Ctn.
Width: 3 1/2"	20 Lbs./Ctn.

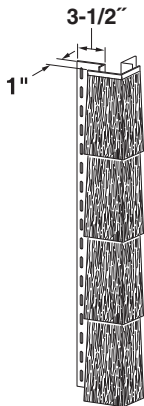

Color Availability

- WHITE** White (04)
- LIGHT** Beige (NB), Pewter (NP), Sand (M4), Sunrise Yellow (IQ), Wicker (A7)
- CLASSIC** French Silk (210), Khaki (N4), Nantucket Gray (N8), Thistle (510)
- DEEP** Canyon (100), Granite (090), Montana Suede (IF), Russet Red (290), Shadow (144), Wedgewood (390), Willow (170)
- SHADED** Shaded Cedar (489), Shaded Gray (490)



THIS PRODUCT HAS BEEN GREEN APPROVED BY THE NABR RESEARCH CENTER.
This means you can be assured that this product complies with specific green practice criteria in the National Green Building Standard. Visit www.GreenApprovedProducts.com for more details.

Triple 5" Shingle

Product Code: **CEDAR5**

Description	Package
Nominal .090" Thick	7 Pcs./Ctn.
Length: 69 1/2"	46 Sq./Ctn.
Exposed Length: 63"	35 Lbs./Ctn.

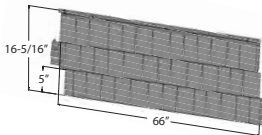

Color Availability

- WHITE** White (04)
- LIGHT** Beige (NB), Pewter (NP), Sand (M4), Sunrise Yellow (IQ), Wicker (A7)
- CLASSIC** French Silk (210), Khaki (N4), Nantucket Gray (N8), Thistle (510)
- DEEP** Canyon (100), Granite (090), Montana Suede (IF), Russet Red (290), Shadow (144), Wedgewood (390), Willow (170)
- SHADED** Shaded Cedar (489), Shaded Gray (490)



THIS PRODUCT HAS BEEN GREEN APPROVED BY THE NABR RESEARCH CENTER.
This means you can be assured that this product complies with specific green practice criteria in the National Green Building Standard. Visit www.GreenApprovedProducts.com for more details.

Triple 5" Shingle Corner Post

Product Code: **CEDAR5CP**

Description	Package
Nominal .080" Thick Length: 31"	10 Pcs./Ctn. 19.5 Lbs./Ctn.

Color Availability

WHITE	White (04)
LIGHT	Beige (NB), Pewter (NP), Sand (M4), Sunrise Yellow (IQ), Wicker (A7)
CLASSIC	French Silk (210), Khaki (N4), Nantucket Gray (N8), Thistle (510)
DEEP	Canyon (100), Granite (090), Montana Suede (IF), Russet Red (290), Shadow (144), Wedgewood (390), Willow (170)
SHADED	Shaded Cedar (489), Shaded Gray (490)



THIS PRODUCT HAS BEEN GREEN APPROVED BY THE NAHB RESEARCH CENTER. This means you can be assured that this product complies with specific green practice criteria in the National Green Building Standard. Visit www.GreenApprovedProducts.com for more details.

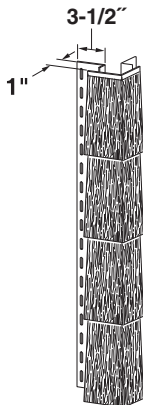

Cedar Finish Trim

Product Code: **CDMFT**

Description	Package
Length: 12' 6"	24 Pcs./Ctn. 25 Lbs./Ctn.

Color Availability

WHITE	White (04)
LIGHT	Beige (NB), Pewter (NP), Sand (M4), Sunrise Yellow (IQ), Wicker (A7)
CLASSIC	Khaki (N4), Nantucket Gray (N8), Thistle (510)
DEEP	Russet Red (290)



THIS PRODUCT HAS BEEN GREEN APPROVED BY THE NAHB RESEARCH CENTER. This means you can be assured that this product complies with specific green practice criteria in the National Green Building Standard. Visit www.GreenApprovedProducts.com for more details.

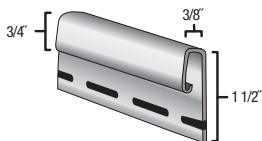

Cedar Dimensions™

Heavy-Duty Metal Starter Strip (Galvanized)

Product Code: **CPSSHD**

Description

Universal Cedar Panel
Length: 10'

Package

25 Pcs./Ctn.
49 Lbs./Ctn.

Color Availability

No color.

IMPROVED

Note: For use with Cedar Dimensions panels. for easier installation

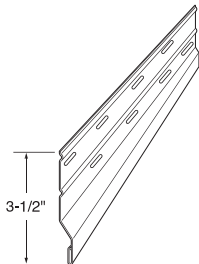

Cedar Dimensions Starter Strip (Aluminum)

Product Code: **CDSS**

Description

Length: 10'

Package

50 Pcs./Ctn.
32 Lbs./Ctn.

Color Availability

No color.

IMPROVED

for easier installation

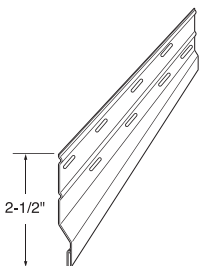

Single 7" Shingle

Product Code: CWVFS7

Description	Package
Nominal .050" Thick Length: 8' 3"	21 Pcs./Ctn. 1 Sqs./Ctn. 74 Lbs./Ctn.

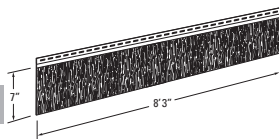

Color Availability

- WHITE** White (04)
- LIGHT** Almond (53), Beige (NB), Olive (511), Pewter (NP), Sand (M4), Wicker (A7)
- CLASSIC** French Silk (210), Khaki (N4)
- DEEP** Canyon (100), Granite (090), Montana Suede (IF), Russet Red (290), Shadow (144), Wedgewood (390), Willow (170)
- CEDAR** Chestnut (28), Hickory (NH), Juniper (86)



THIS PRODUCT HAS BEEN GREEN APPROVED BY THE NAHB RESEARCH CENTER.
This means you can be assured that this product complies with specific green practice criteria in the National Green Building Standard. Visit www.GreenApprovedProducts.com for more details.

Single 9" Shake

Product Code: CWVFS9

Description	Package
Nominal .050" Thick Length: 8' 3"	16 Pcs./Ctn. 1 Sqs./Ctn. 56 Lbs./Ctn.

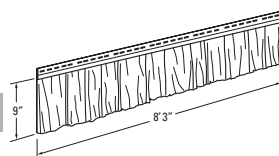

Color Availability

- WHITE** White (04)
- LIGHT** Almond (53), Beige (NB), Olive (511), Pewter (NP), Sand (M4), Wicker (A7)
- CLASSIC** French Silk (210), Khaki (N4)
- DEEP** Canyon (100), Granite (090), Montana Suede (IF), Russet Red (290), Shadow (144), Wedgewood (390), Willow (170)
- CEDAR** Chestnut (28), Hickory (NH), Juniper (86)



THIS PRODUCT HAS BEEN GREEN APPROVED BY THE NAHB RESEARCH CENTER.
This means you can be assured that this product complies with specific green practice criteria in the National Green Building Standard. Visit www.GreenApprovedProducts.com for more details.

Dimensions® Double 4"

Product Code: **DI40**

Description	Package
Nominal .044" Thick	24 Pcs./Ctn.
Length: 12' 6"	2 Sqs./Ctn.
	108 Lbs./Ctn.

Color Availability

WHITE White (04)

LIGHT Almond (53), Autumn Tan (M6), Olive (511), Pewter (NP), Sand (M4), Wicker (A7)

CLASSIC French Silk (210), Khaki (N4), Nantucket Gray (N8), Slate Blue (N1), Thistle (510)

DEEP Canyon (100), Granite (090), Montana Suede (IF), Russet Red (290), Shadow(144), Wedgewood (390), Willow (170)

CEDAR Chestnut (28), Hickory (NH), Juniper (86), Spruce Blue (61)



THIS PRODUCT HAS BEEN GREEN APPROVED BY THE NAB® RESEARCH CENTER. This means you can be assured that this product complies with specific green practice criteria in the National Green Building Standard. Visit www.GreenApprovedProducts.com for more details.

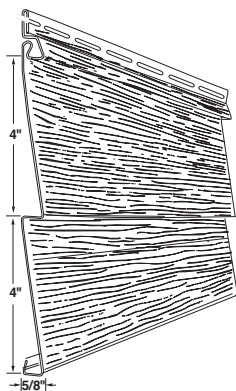

Dimensions® Double 4-1/2" Dutch Lap

Product Code: **DID45**

Description	Package
Nominal .044" Thick	22 Pcs./Ctn.
Length: 12' 1"	2 Sqs./Ctn.
	106 Lbs./Ctn.

Color Availability

WHITE White (04)

LIGHT Almond (53), Autumn Tan (M6), Olive (511), Pewter (NP), Sand (M4), Wicker (A7)

CLASSIC French Silk (210), Khaki (N4), Nantucket Gray (N8), Slate Blue (N1), Thistle (510)

DEEP Canyon (100), Granite (090), Montana Suede (IF), Russet Red (290), Shadow(144), Wedgewood (390), Willow (170)

CEDAR Chestnut (28), Hickory (NH), Juniper (86), Spruce Blue (61)



THIS PRODUCT HAS BEEN GREEN APPROVED BY THE NAB® RESEARCH CENTER. This means you can be assured that this product complies with specific green practice criteria in the National Green Building Standard. Visit www.GreenApprovedProducts.com for more details.

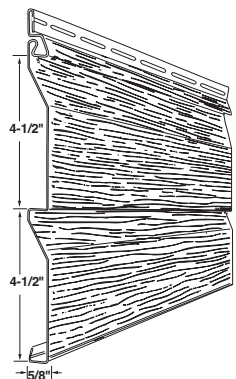

Progressions® Double 4"

Product Code: PG40

Description	Package
Nominal .042" Thick Length: 12' 6"	24 Pcs./Ctn. 2 Sqs./Ctn. 95 Lbs./Ctn.

Color Availability

- WHITE** White (04)
- LIGHT** Almond (53), Autumn Tan (M6), Beige (NB), Ivory (N3), Mist (NM), Olive (511), Pewter (NP), Sand (M4), Stone Gray (NS), Sunrise Yellow (IQ), Wicker (A7)
- CLASSIC** French Silk (210), Khaki (N4), Nantucket Gray (N8), Slate Blue (N1), Thistle (510)
- DEEP** Canyon (100), Granite (090), Wedgewood (390), Willow (170)



Home Innovation
NGBS GREEN CERTIFIED
RESOURCE EFFICIENCY

THIS PRODUCT HAS BEEN GREEN APPROVED BY THE NAHB RESEARCH CENTER. This means you can be assured that this product complies with specific green practice criteria in the National Green Building Standard. Visit www.GreenApprovedProducts.com for more details.

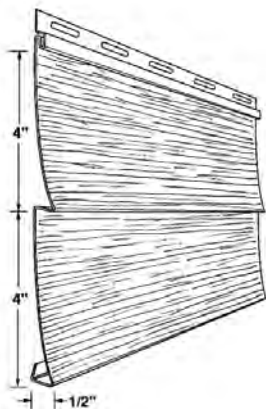

Progressions® Double 5"

Product Code: PG50

Description	Package
Nominal .042" Thick Length: 12'	20 Pcs./Ctn. 2 Sqs./Ctn. 89 Lbs./Ctn.

Color Availability

- WHITE** White (04)
- LIGHT** Almond (53), Autumn Tan (M6), Beige (NB), Ivory (N3), Mist (NM), Olive (511), Pewter (NP), Sand (M4), Stone Gray (NS), Sunrise Yellow (IQ), Wicker (A7)
- CLASSIC** Khaki (N4), Nantucket Gray (N8), Slate Blue (N1), Thistle (510)



Home Innovation
NGBS GREEN CERTIFIED
RESOURCE EFFICIENCY

THIS PRODUCT HAS BEEN GREEN APPROVED BY THE NAHB RESEARCH CENTER. This means you can be assured that this product complies with specific green practice criteria in the National Green Building Standard. Visit www.GreenApprovedProducts.com for more details.

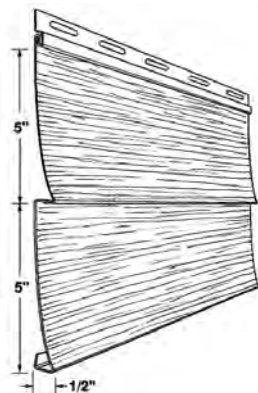

Progressions® Double 4-1/2" Dutch Lap

Product Code: PGD45

Description	Package
Nominal .042" Thick Exposure: 12' 1"	22 Pcs./Ctn. 2 Sqs./Ctn. 92 Lbs./Ctn.

Color Availability

- WHITE** White (04)
- LIGHT** Almond (53), Autumn Tan (M6), Beige (NB), Ivory (N3), Mist (NM), Olive (511), Pewter (NP), Sand (M4), Stone Gray (NS), Sunrise Yellow (IQ), Wicker (A7)
- CLASSIC** French Silk (210), Khaki (N4), Nantucket Gray (N8), Slate Blue (N1), Thistle (510)
- DEEP** Canyon (100), Granite (090), Wedgewood (390), Willow (170)



Home Innovation
NGBS GREEN CERTIFIED
RESOURCE EFFICIENCY

THIS PRODUCT HAS BEEN GREEN APPROVED BY THE NAHB RESEARCH CENTER. This means you can be assured that this product complies with specific green practice criteria in the National Green Building Standard. Visit www.GreenApprovedProducts.com for more details.

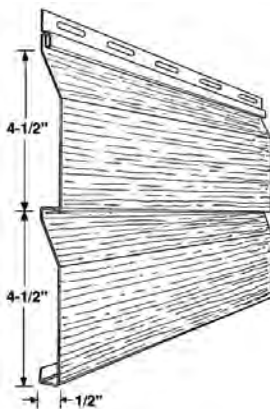

Progressions® Double 5" Dutch Lap

Product Code: PGD50

Description	Package
Nominal .042" Thick	20 Pcs./Ctn.
Length: 12'	2 Sqs./Ctn.
	85 Lbs./Ctn.

Color Availability

WHITE White (04)

LIGHT Almond (53), Autumn Tan (M6), Beige (NB), Ivory (N3), Mist (NM), Olive (511), Pewter (NP), Sand (M4), Stone Gray (NS), Sunrise Yellow (IQ), Wicker (A7)

CLASSIC Khaki (N4), Nantucket Gray (N8), Slate Blue (N1), Thistle (510)



THIS PRODUCT HAS BEEN GREEN APPROVED BY THE NAHB RESEARCH CENTER. This means you can be assured that this product complies with specific green practice criteria in the National Green Building Standard. Visit www.GreenApprovedProducts.com for more details.

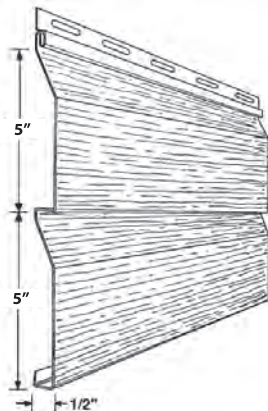

Progressions® Triple 3"

Product Code: PG30

Description	Package
Finish: Matte	22 Pcs./Ctn.
Nominal .042" Thick	2 Sqs./Ctn.
Length: 12' 1"	103 Lbs./Ctn.

Color Availability

WHITE White (04)

LIGHT Almond (53), Autumn Tan (M6), Beige (NB), Ivory (N3), Mist (NM), Olive (511), Pewter (NP), Sand (M4), Stone Gray (NS), Sunrise Yellow (IQ), Wicker (A7)

CLASSIC Khaki (N4), Nantucket Gray (N8), Slate Blue (N1), Thistle (510)



THIS PRODUCT HAS BEEN GREEN APPROVED BY THE NAHB RESEARCH CENTER. This means you can be assured that this product complies with specific green practice criteria in the National Green Building Standard. Visit www.GreenApprovedProducts.com for more details.

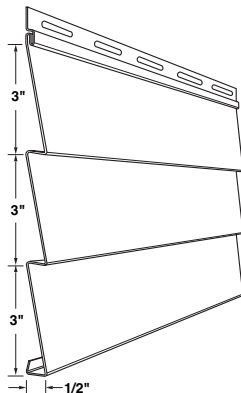

Evolutions® Double 4"

Product Code: **EL40**

Description	Package
Nominal .040" Thick Length: 12' 6"	24 Pcs./Ctn. 2 Sqs./Ctn. 93 Lbs./Ctn.

Color Availability

- WHITE** White (04)
- LIGHT** Almond (53), Autumn Tan (M6), Beige (NB), Ivory (N3), Mist (NM), Olive (511), Pewter (NP), Sand (M4), Stone Gray (NS), Wicker (A7)
- CLASSIC** Khaki (N4), Slate Blue (N1)



THIS PRODUCT HAS BEEN GREEN APPROVED BY THE NAHB RESEARCH CENTER. This means you can be assured that this product complies with specific green practice criteria in the National Green Building Standard. Visit www.GreenApprovedProducts.com for more details.

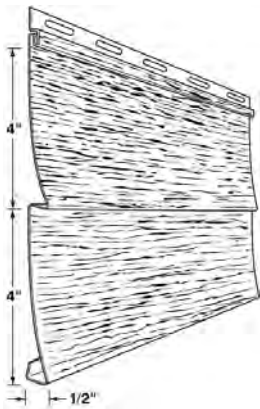

Evolutions® Double 5"

Product Code: **EL50**

Description	Package
Nominal .040" Thick Length: 12'	20 Pcs./Ctn. 2 Sqs./Ctn. 88 Lbs./Ctn.

Color Availability

- WHITE** White (04)
- LIGHT** Almond (53), Autumn Tan (M6), Beige (NB), Ivory (N3), Mist (NM), Olive (511), Pewter (NP), Sand (M4), Stone Gray (NS), Wicker (A7)
- CLASSIC** Khaki (N4), Slate Blue (N1)



THIS PRODUCT HAS BEEN GREEN APPROVED BY THE NAHB RESEARCH CENTER. This means you can be assured that this product complies with specific green practice criteria in the National Green Building Standard. Visit www.GreenApprovedProducts.com for more details.

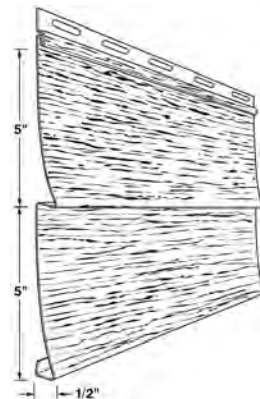

Evolutions® Double 4-1/2" Dutch Lap

Product Code: **ELD45**

Description	Package
Nominal .040" Thick Exposure: 12' 1"	22 Pcs./Ctn. 2 Sqs./Ctn. 90 Lbs./Ctn.

Color Availability

- WHITE** White (04)
- LIGHT** Almond (53), Autumn Tan (M6), Beige (NB), Ivory (N3), Mist (NM), Olive (511), Pewter (NP), Sand (M4), Stone Gray (NS), Wicker (A7)
- CLASSIC** Khaki (N4), Slate Blue (N1)



THIS PRODUCT HAS BEEN GREEN APPROVED BY THE NAHB RESEARCH CENTER. This means you can be assured that this product complies with specific green practice criteria in the National Green Building Standard. Visit www.GreenApprovedProducts.com for more details.

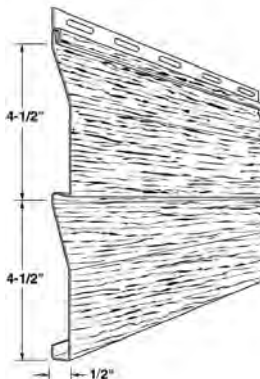

Colonial 6-1/2" Beaded

Product Code: **PB65M**

Description	Package
Nominal .044" Thick	30 Pcs./Ctn.
Length: 12' 4"	2 Sqs./Ctn.
	115 Lbs./Ctn.

Color Availability

- WHITE** White (04)
- LIGHT** Beige (NB), Pewter (NP), Sand (M4), Wicker (A7)
- CLASSIC** French Silk (210), Khaki (N4), Thistle (510)



THIS PRODUCT HAS BEEN GREEN APPROVED BY THE NABR RESEARCH CENTER.
This means you can be assured that this product complies with specific green practice criteria in the National Green Building Standard. Visit www.GreenApprovedProducts.com for more details.

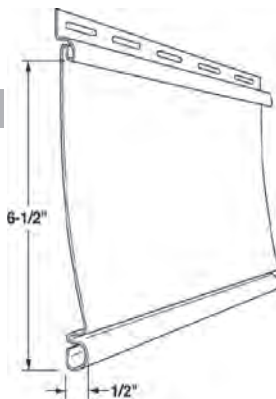

Note: For use with starter strip 1WAP10

Board/Batten 5-1/2" Board with 1-1/2" Batten

Product Code: **PBB70W**

Description	Package
Nominal .048" Thick	17 Pcs./Ctn.
Length: 10'	1 Sq./Ctn.
	60 Lbs./Ctn.

Color Availability

- WHITE** White (04)
- LIGHT** Autumn Tan (M6), Beige (NB), Pewter (NP), Sand (M4), Wicker (A7)
- CLASSIC** French Silk (210), Khaki (N4), Nantucket Gray (N8), Thistle (510)
- DEEP** Canyon (100), Montana Suede (1F), Russet Red (290), Wedgewood (390), Willow (170)



THIS PRODUCT HAS BEEN GREEN APPROVED BY THE NABR RESEARCH CENTER.
This means you can be assured that this product complies with specific green practice criteria in the National Green Building Standard. Visit www.GreenApprovedProducts.com for more details.

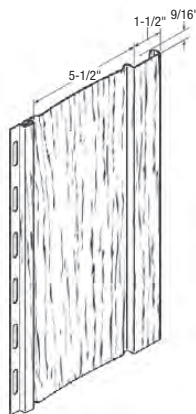

HIDDEN VENT SOFFIT

Triple 3-1/3" Solid Soffit/Wainscot

Product Code: VST3N

Description	Package
Nominal .044" Thick	20 Pcs./Ctn.
Finish: Matte	2 Sqs./Ctn.
Length: 12'	121 Lbs./Ctn.

Color Availability

WHITE	White (04)
LIGHT	Almond (53), Autumn Tan (M6), Beige (NB), Ivory (N3), Mist (NM), Olive (511), Pewter (NP), Sand (M4), Stone Gray (NS), Sunrise Yellow (IQ), Wicker (A7)
CLASSIC	French Silk (210), Khaki (N4), Nantucket Gray (N8), Slate Blue (N1), Thistle (510)
DEEP	Canyon (100), Granite (090), Montana Suede (IF), Russet Red (290), Shadow (144), Wedgewood (390), Willow (170)
DARK	Musket Brown (59)

Note: All colors except Musket Brown are warranted for sidewall use.

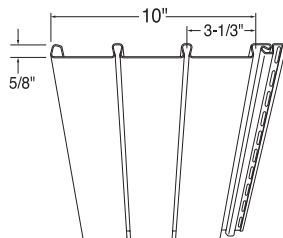

Triple 3-1/3" Hidden Vent Soffit

Product Code: VST3V

Description	Package
Nominal .044" Thick	20 Pcs./Ctn.
Finish: Matte	2 Sqs./Ctn.
Length: 12'	122 Lbs./Ctn.
	9.19 Sq. In./Sq. Ft.

Color Availability

WHITE	White (04)
LIGHT	Almond (53), Autumn Tan (M6), Beige (NB), Ivory (N3), Mist (NM), Olive (511), Pewter (NP), Sand (M4), Stone Gray (NS), Sunrise Yellow (IQ), Wicker (A7)
CLASSIC	French Silk (210), Khaki (N4), Nantucket Gray (N8), Slate Blue (N1), Thistle (510)
DEEP	Canyon (100), Granite (090), Montana Suede (IF), Russet Red (290), Shadow (144), Wedgewood (390), Willow (170)
DARK	Musket Brown (59)

Note: Not warranted for sidewall use.

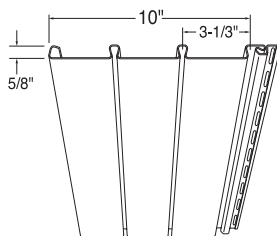

BEADED VINYL SOFFIT

Beaded 8" Non-Ventilated Soffit/Wainscot

Product Code: VSB223N

Description	Package
Nominal .040" Thick	24 Pcs./Ctn.
Finish: Matte	2 Sqs./Ctn.
Length: 12' 6"	116 Lbs./Ctn.

Color Availability

WHITE White (04)



THIS PRODUCT HAS BEEN GREEN APPROVED BY THE NAHB RESEARCH CENTER.
This means you can be assured that this product complies with specific green practice criteria in the National Green Building Standard. Visit www.GreenApprovedProducts.com for more details.

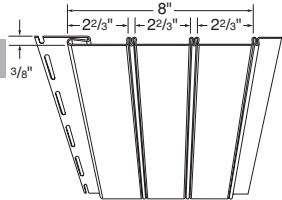

Note: Warranted for sidewall use.

Beaded 8" Ventilated Soffit

Product Code: VSB223V

Description	Package
Nominal .040" Thick	24 Pcs./Ctn.
Finish: Matte	2 Sqs./Ctn.
Length: 12' 6"	116 Lbs./Ctn.
	1.54 Sq. In. N.F.A./Sq. Ft.

Color Availability

WHITE White (04)



THIS PRODUCT HAS BEEN GREEN APPROVED BY THE NAHB RESEARCH CENTER.
This means you can be assured that this product complies with specific green practice criteria in the National Green Building Standard. Visit www.GreenApprovedProducts.com for more details.

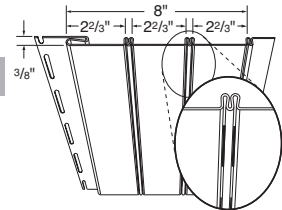

Note: Not warranted for sidewall use.

Beaded J-Channel 3/8"

Product Code: VJCB38

Description	Package
Nominal .040" Thick	24 Pcs./Ctn.
Finish: Matte	300 Ft./Ctn.
Exposure: 12' 6"	39 Lbs./Ctn.

Color Availability

WHITE White (04)

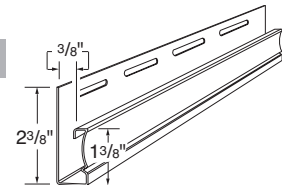

PREMIUM VINYL SOFFIT

Triple 4" Premium Soffit Non-Ventilated Panel

Product Code: VST4N

Description	Package
Nominal .040" Thick	16 Pcs./Ctn.
Finish: Matte	1.92 Sqs./Ctn.
Length: 12'	90 Lbs./Ctn.

Color Availability

- WHITE** White (04)
- LIGHT** Almond (53), Autumn Tan (M6), Beige (NB), Ivory (N3), Mist (NM), Olive (511), Pewter (NP), Sand (M4), Stone Gray (NS), Wicker (A7)
- CLASSIC** Khaki (N4), Nantucket Gray (N8), Slate Blue (N1), Thistle (510)
- DEEP** Musket Brown (59)

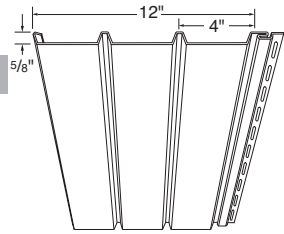

Note: All colors except Musket Brown are warranted for sidewall use.



THIS PRODUCT HAS BEEN GREEN APPROVED BY THE NAHB RESEARCH CENTER. This means you can be assured that this product complies with specific green practice criteria in the National Green Building Standard. Visit www.GreenApprovedProducts.com for more details.

Triple 4" Premium Soffit Full-Ventilated Panel

Product Code: VST4V

Description	Package
Nominal .040" Thick	16 Pcs./Ctn.
Finish: Matte	1.92 Sqs./Ctn.
Length: 12'	88 Lbs./Ctn.
	5.87 Sq. In. N.F.A./Sq. Ft.

Color Availability

- WHITE** White (04)
- LIGHT** Almond (53), Autumn Tan (M6), Beige (NB), Ivory (N3), Mist (NM), Olive (511), Pewter (NP), Sand (M4), Stone Gray (NS), Wicker (A7)
- CLASSIC** Khaki (N4), Nantucket Gray (N8), Slate Blue (N1), Thistle (510)
- DARK** Musket Brown (59)

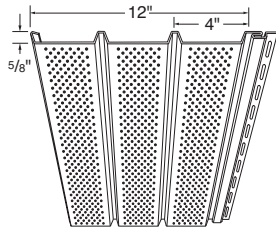

Note: Not warranted for sidewall use.



THIS PRODUCT HAS BEEN GREEN APPROVED BY THE NAHB RESEARCH CENTER. This means you can be assured that this product complies with specific green practice criteria in the National Green Building Standard. Visit www.GreenApprovedProducts.com for more details.

Triple 4" Premium Soffit Center-Ventilated Panel

Product Code: VST4CV

Description	Package
Nominal .040" Thick	16 Pcs./Ctn.
Finish: Matte	1.92 Sqs./Ctn.
Exposure: 12'	89 Lbs./Ctn.
	1.96 Sq. In. N.F.A./Sq. Ft.

Color Availability

- WHITE** White (04)

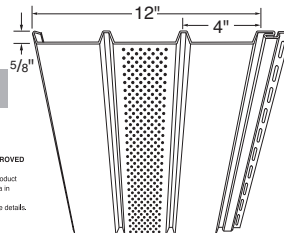

Note: Not warranted for sidewall use.



THIS PRODUCT HAS BEEN GREEN APPROVED BY THE NAHB RESEARCH CENTER. This means you can be assured that this product complies with specific green practice criteria in the National Green Building Standard. Visit www.GreenApprovedProducts.com for more details.

PREMIUM VINYL SOFFIT

Double 5" Premium Soffit Non-Ventilated Panel

Product Code: **VSD5N**

Description	Package
Nominal .046" Thick	20 Pcs./Ctn.
Finish: Brushed	2 Sqs./Ctn.
Length: 12'	107 Lbs./Ctn.

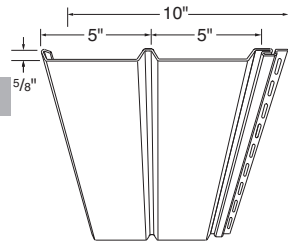

Color Availability

- WHITE** White (04)
- LIGHT** Almond (53), Autumn Tan (M6), Ivory (N3), Pewter (NP), Sand (M4), Wicker (A7)
- CLASSIC** Khaki (N4)
- DARK** Musket Brown (59)

Note: All colors except Musket Brown are warranted for sidewall use.



THIS PRODUCT HAS BEEN GREEN APPROVED BY THE NAHB RESEARCH CENTER. This means you can be assured that this product complies with specific green practice criteria in the National Green Building Standard. Visit www.GreenApprovedProducts.com for more details.

Double 5" Premium Soffit Ventilated Panel

Product Code: **VSD5FV**

Description	Package
Nominal .046" Thick	20 Pcs./Ctn.
Finish: Brushed	2 Sqs./Ctn.
Length: 12'	104 Lbs./Ctn.
	7.53 Sq. In. N.F.A./Sq. Ft.

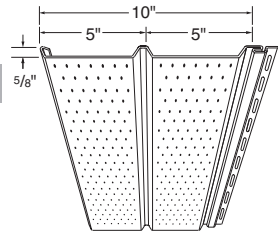

Color Availability

- WHITE** White (04)
- LIGHT** Almond (53), Autumn Tan (M6), Ivory (N3), Pewter (NP), Sand (M4), Wicker (A7)
- CLASSIC** Khaki (N4)
- DARK** Musket Brown (59)

Note: Not warranted for sidewall use.



THIS PRODUCT HAS BEEN GREEN APPROVED BY THE NAHB RESEARCH CENTER. This means you can be assured that this product complies with specific green practice criteria in the National Green Building Standard. Visit www.GreenApprovedProducts.com for more details.

STANDARD VINYL SOFFIT

Double 5" Standard Soffit

Product Code: **SVSD5N**

Description	Package
Nominal .042" Thick	20 Pcs./Ctn.
Finish: Matte	2 Sqs./Ctn.
Length: 12'	94 Lbs./Ctn.

Color Availability

WHITE	White (04)
LIGHT	Almond (53), Autumn Tan (M6), Ivory (N3), Pewter (NP), Sand (M4), Wicker (A7)
CLASSIC	Khaki (N4)

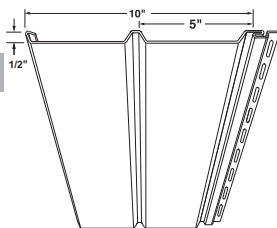

THIS PRODUCT HAS BEEN GREEN APPROVED BY THE NAHB RESEARCH CENTER.

This means you can be assured that this product complies with specific green practice criteria in the National Green Building Standards. Visit www.GreenApprovedProducts.com for more details.

Note: Not warranted for sidewall use.

Double 5" Vented Soffit

Product Code: **SVSD5FV**

Description	Package
Nominal .042" Thick	20 Pcs./Ctn.
Finish: Matte	2 Sqs./Ctn.
Length: 12'	91 Lbs./Ctn.
	7.53 Sq. In. N.F.A./Sq. Ft.

Color Availability

WHITE	White (04)
LIGHT	Almond (53), Autumn Tan (M6), Ivory (N3), Pewter (NP), Sand (M4), Wicker (A7)
CLASSIC	Khaki (N4)

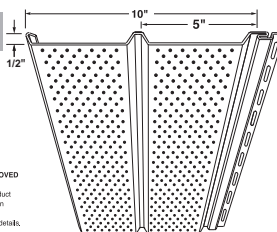

THIS PRODUCT HAS BEEN GREEN APPROVED BY THE NAHB RESEARCH CENTER.

This means you can be assured that this product complies with specific green practice criteria in the National Green Building Standards. Visit www.GreenApprovedProducts.com for more details.

Note: Not warranted for sidewall use.

ECONOMY VINYL SOFFIT

Economy Soffit Double 5" Non-Ventilated Panel

Product Code: EVSD5N

Description	Package
Nominal .040" Thick	20 Pcs./Ctn.
Finish: Woodgrain	2 Sqs./Ctn.
Length: 12'	90 Lbs./Ctn.

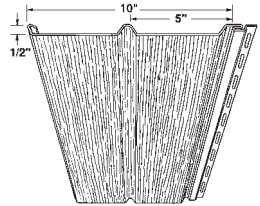

Color Availability

- WHITE** White (04)
- LIGHT** Almond (53), Autumn Tan (M6), Ivory (N3), Sand (M4)
- CLASSIC** Khaki (N4)



THIS PRODUCT HAS BEEN GREEN APPROVED BY THE NAHB RESEARCH CENTER. This means you can be assured that this product complies with specific green practice criteria in the National Green Building Standard. Visit www.GreenApprovedProducts.com for more details.

Note: Not warranted for sidewall use.

Economy Soffit Double 5" Ventilated Panel

Product Code: EVSD5V

Description	Package
Nominal .040" Thick	20 Pcs./Ctn.
Finish: Woodgrain	2 Sqs./Ctn.
Length: 12'	87 Lbs./Ctn.
	7.53 Sq. In. N.F.A./Sq. Ft.

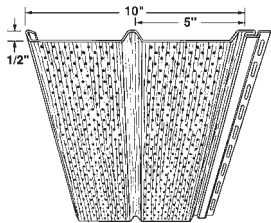

Color Availability

- WHITE** White (04)
- LIGHT** Almond (53), Autumn Tan (M6), Ivory (N3), Sand (M4)
- CLASSIC** Khaki (N4)



THIS PRODUCT HAS BEEN GREEN APPROVED BY THE NAHB RESEARCH CENTER. This means you can be assured that this product complies with specific green practice criteria in the National Green Building Standard. Visit www.GreenApprovedProducts.com for more details.

Note: Not warranted for sidewall use.

Economy Soffit Triple 4" Non-Ventilated Panel

Product Code: EVS12N

Description	Package
Nominal .036" Thick	16 Pcs./Ctn.
Finish: Matte	1.92 Sqs./Ctn.
Exposure: 12'	80 Lbs./Ctn.

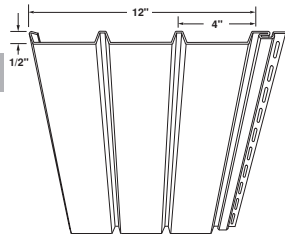

Color Availability

- WHITE** White (04)
- LIGHT** Almond (53), Autumn Tan (M6), Ivory (N3), Sand (M4)
- CLASSIC** Khaki (N4)



THIS PRODUCT HAS BEEN GREEN APPROVED BY THE NAHB RESEARCH CENTER. This means you can be assured that this product complies with specific green practice criteria in the National Green Building Standard. Visit www.GreenApprovedProducts.com for more details.

Note: Not warranted for sidewall use.

ECONOMY VINYL SOFFIT

Economy Soffit Triple 4" Ventilated Panel

Product Code: EVS12P

Description	Package
Nominal .036" Thick	16 Pcs./Ctn.
Finish: Matte	1.92 Sqs./Ctn.
Length: 12'	75 Lbs./Ctn.
	5.87 Sq. In. N.F.A./Sq. Ft.

Color Availability

WHITE	White (04)
LIGHT	Almond (53), Autumn Tan (M6), Ivory (N3), Sand (M4)
CLASSIC	Khaki (N4)

Note: Not warranted for sidewall use.



THIS PRODUCT HAS BEEN GREEN APPROVED BY THE NAHB RESEARCH CENTER. This means you can be assured that this product complies with specific green practice criteria in the National Green Building Standard. Visit www.GreenApprovedProducts.com for more details.

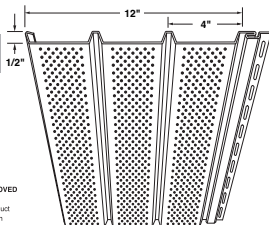

Economy Soffit Triple 4" Center-Ventilated Panel

Product Code: EVS12CP

Description	Package
Nominal .036" Thick	16 Pcs./Ctn.
Finish: Matte	1.92 Sqs./Ctn.
Length: 12'	78 Lbs./Ctn.
	1.96 Sq. In. N.F.A./Sq. Ft.

Color Availability

WHITE	White (04)
--------------	------------

Note: Not warranted for sidewall use.



THIS PRODUCT HAS BEEN GREEN APPROVED BY THE NAHB RESEARCH CENTER. This means you can be assured that this product complies with specific green practice criteria in the National Green Building Standard. Visit www.GreenApprovedProducts.com for more details.

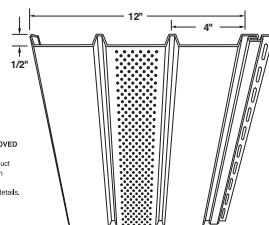

8" Vinyl Fascia

Product Code: VFAS8

Description

Length: 12' 6"

Package

24 Pcs./Ctn.
98 Lbs./Ctn.

Color Availability

WHITE White (04)

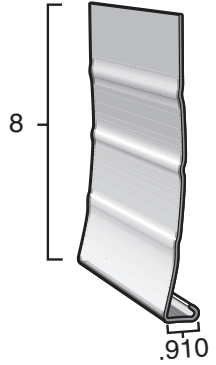

Vinyl Starter Strip

Product Code: **VS12**

Description

Length: 12' 6"

Package

40 Pcs./Ctn.
69 Lbs./Ctn.

Color Availability

No color

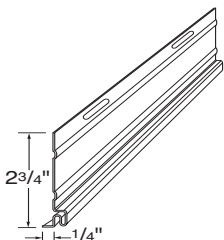

Aluminum Starter Strip (Spring Style)

Product Code: **VSS10NS**

Description

Length: 10'

Package

50 Pcs./Ctn.
33 Lbs./Ctn.

Color Availability

No color

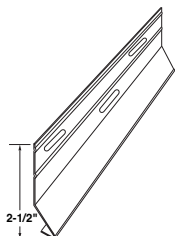

Aluminum Starter Strip

Product Code: **1WAP10**

Description

Length: 10'

Package

40 Pcs./Ctn.
27 Lbs./Ctn.

Color Availability

No color

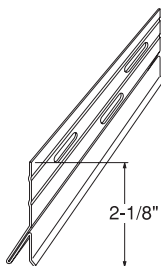

Note: Required Starter Strip for Colonial Beaded.

Galvanized Steel Starter Strip

Product Code: **ASVSS25**

Description

Length: 10'

Package

25 Pcs./Ctn.
40 Lbs./Ctn.

Color Availability

No color

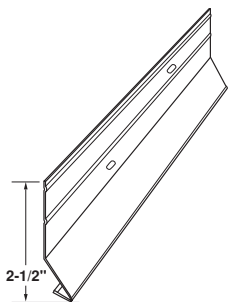

3" Universal Outside Corner Post — 3/4"

Product Code: **VOCP334**

Description	Package
Length: 10'	10 Pcs./Ctn. 39 Lbs./Ctn.

Color Availability

- WHITE** White (04)
- LIGHT** Almond (53), Autumn Tan (M6), Beige (NB), Ivory (N3), Mist (NM), Olive (511), Pewter (NP), Sand (M4), Stone Gray (NS), Sunrise Yellow (IQ), Wicker (A7)
- CLASSIC** French Silk (210), Khaki (N4), Nantucket Gray (N8), Slate Blue (N1), Thistle (510)

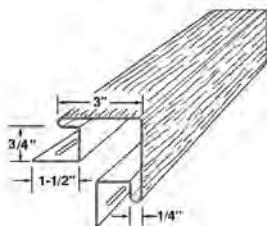

4" Universal Outside Corner Post — 3/4"

Product Code: **VOCP34N**

Description	Package
Length: 10'	10 Pcs./Ctn. 50 Lbs./Ctn.

Color Availability

- DEEP** Canyon (100), Granite (090), Montana Suede (IF), Russet Red (290), Shadow (144), Wedgewood (390), Willow (170)
- CEDAR** Chestnut (28), Hickory (NH), Juniper (86), Spruce Blue (61)

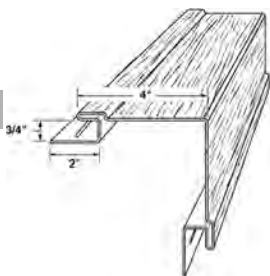

Inside Corner Post — 3/4"

Product Code: **ICP34**

Description	Package
Length: 10'	10 Pcs./Ctn. 24.43 Lbs./Ctn.

Color Availability

- White** White (04)
- LIGHT** Almond (53), Autumn Tan (M6), Beige (NB), Ivory (N3), Mist (NM), Olive (511), Pewter (NP), Sand (M4), Stone Gray (NS), Sunrise Yellow (IQ), Wicker (A7)
- CLASSIC** French Silk (210), Khaki (N4), Nantucket Gray (N8), Slate Blue (N1), Thistle (510)
- DEEP** Canyon (100), Granite (090), Montana Suede (IF), Russet Red (290), Shadow (144), Wedgewood (390), Willow (170)
- CEDAR** Chestnut (28), Hickory (NH), Juniper (86), Spruce Blue (61)

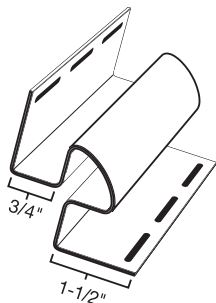

Economy Soffit J-Channel — 1/2"

Product Code: **VJC04**

Description

Length: 12' 6"

Package

40 Pcs./Ctn.
41 Lbs./Ctn.

Color Availability

WHITE White (04)

LIGHT Almond (53), Autumn Tan (M6), Beige (NB), Ivory (N3), Mist (NM), Olive (511), Pewter (NP), Sand (M4), Stone Gray (NS), Sunrise Yellow (IQ), Wicker (A7)

CLASSIC Khaki (N4), Nantucket Gray (N8), Slate Blue (N1), Thistle (510)

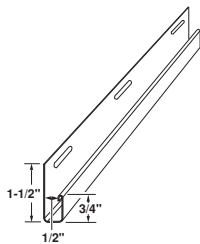

All Purpose J-Channel — 5/8"

Product Code: **VJC581**

Description

Length: 12' 6"

Package

40 Pcs./Ctn.
42 Lbs./Ctn.

Color Availability

WHITE White (04)

LIGHT Almond (53), Autumn Tan (M6), Beige (NB), Ivory (N3), Mist (NM), Olive (511), Pewter (NP), Sand (M4), Stone Gray (NS), Sunrise Yellow (IQ), Wicker (A7)

CLASSIC French Silk (210), Khaki (N4), Nantucket Gray (N8), Slate Blue (N1), Thistle (510)

DEEP Canyon (100), Granite (090), Montana Suede (IF), Russet Red (290), Shadow (144), Wedgewood (390), Willow (170)

CEDAR Chestnut (28), Hickory (NH), Juniper (86), Spruce Blue (61)

DARK Musket Brown (59)

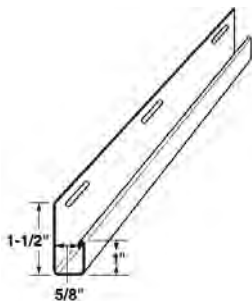

All Purpose J-Channel — 7/8"

Product Code: **VJC78**

Description

Length: 12' 6"

Package

40 Pcs./Ctn.
48 Lbs./Ctn.

Color Availability

WHITE White (04)

LIGHT Beige (NB), Pewter (NP), Sand (M4), Sunrise Yellow (IQ), Wicker (A7)

CLASSIC French Silk (210), Khaki (N4), Nantucket Gray (N8), Thistle (510)

DEEP Montana Suede (IF), Russet Red (290), Shadow (144), Wedgewood (390), Willow (170)

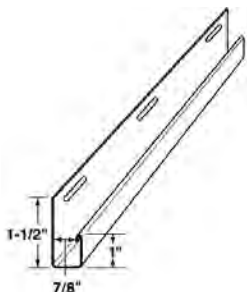

Flexible J-Channel — 1"

Product Code: **MVFJ0341**

Description

Length: 12' 6"

Throat width: 13/16"

Package

20 Pcs./Ctn.
66 Lbs./Ctn.

Color Availability

WHITE White (04)

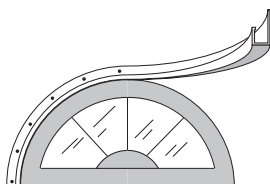

VINYL SIDING & SOFFIT ACCESSORIES

Finish Trim

Product Code: VFT

Description	Package
Length: 12' 6"	40 Pcs./Ctn. 23 Lbs./Ctn.

Color Availability

- WHITE** White (04)
- LIGHT** Almond (53), Autumn Tan (M6), Beige (NB), Ivory (N3), Mist (NM), Olive (511), Pewter (NP), Sand (M4), Stone Gray (NS), Sunrise Yellow (IQ), Wicker (A7)
- CLASSIC** French Silk (210), Khaki (N4), Nantucket Gray (N8), Slate Blue (N1), Thistle (510)
- DEEP** Canyon (100), Granite (090), Montana Suede (IF), Russet Red (290), Shadow (144), Wedgewood (390), Willow (170)
- CEDAR** Chestnut (28), Hickory (NH), Juniper (86), Spruce Blue (61)

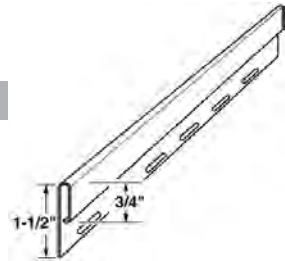

Double Finish Trim

Product Code: MVDF

Description	Package
Length: 12' 6"	20 Pcs./Ctn. 31 Lbs./Ctn.

Color Availability

- WHITE** White (04)
- LIGHT** Almond (53), Autumn Tan (M6), Beige (NB), Ivory (N3), Mist (NM), Olive (511), Pewter (NP), Sand (M4), Stone Gray (NS), Sunrise Yellow (IQ), Wicker (A7)
- CLASSIC** Khaki (N4), Nantucket Gray (N8), Slate Blue (N1), Thistle (510)

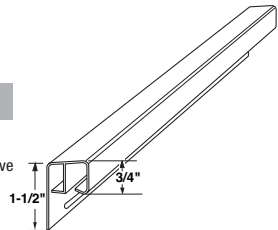

F-Channel — 1/2"

Product Code: VFCH04

Description	Package
Length: 12' 6"	40 Pcs./Ctn. 46 Lbs./Ctn.

Color Availability

- WHITE** White (04)

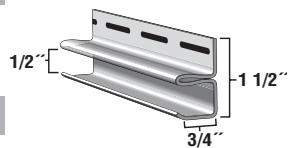

F-Channel — 5/8"

Product Code: VFC58

Description	Package
Length: 12' 6"	24 Pcs./Ctn. 40 Lbs./Ctn.

Color Availability

- White** White (04)
- LIGHT** Almond (53), Autumn Tan (M6), Ivory (N3), Sand (M4), Wicker (A7)
- CLASSIC** Khaki (N4)
- DARK** Musket Brown (59)

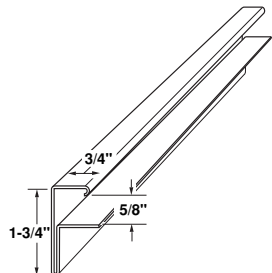

T-Channel — 5/8"

Product Code: **MVTC05**

Description

Length: 12' 6"

Package

12 Pcs./Ctn.

33 Lbs./Ctn.

Color Availability

WHITE White (04)

LIGHT Almond (53), Autumn Tan (M6), Ivory (N3), Sand (M4), Wicker (A7)

CLASSIC Khaki (N4)

DARK Musket Brown (59)

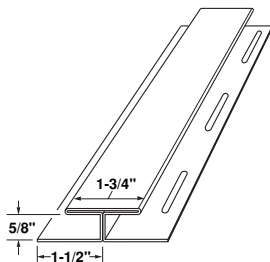

Traditional 5-1/2" Outside Corner Post with Foam Insert Product Code: TF0P55

Description

Length: 20'

Package

4 Pcs./Ctn.

67 Lbs./Ctn.

Color Availability

WHITE White (04)

LIGHT Ivory (N3), Sand (M4), Wicker (A7)

CLASSIC Khaki (N4)

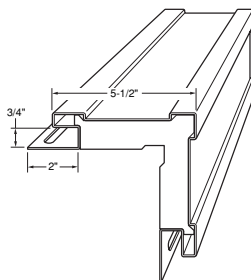

Fluted 5-1/2" Outside Corner Post with Foam Insert Product Code: FF0P55

Product Code: **FF0P55**

Description

Length: 20'

Package

4 Pcs./Ctn.

67 Lbs./Ctn.

Color Availability

WHITE White (04)

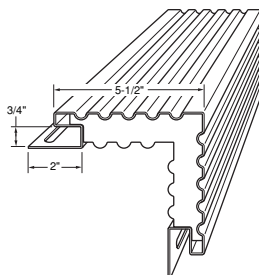

5" Fluted Corner Lineal

Product Code: **LINF5**

Description	Package
Length: 20'	10 Pcs./Ctn. 31 Lbs./Ctn.

Color Availability

WHITE White (04)

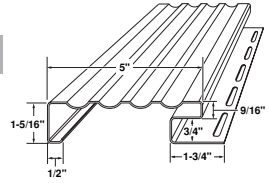

5" Lineal

Product Code: **LIN5**

Description	Package
Length: 20'	10 Pcs./Ctn. 31 Lbs./Ctn.

Color Availability

WHITE White (04)

LIGHT Ivory (N3), Sand (M4), Wicker (A7)

CLASSIC Khaki (N4)

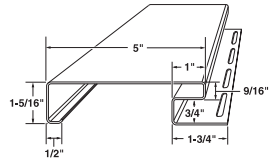

Corner Starter & Insert

Product Code: **LINQRS**

Description	Package
Length: 20'	10 Pcs./Ctn. 27 Lbs./Ctn.

Color Availability

White White (04)

LIGHT Ivory (N3), Sand (M4), Wicker (A7)

CLASSIC Khaki (N4)

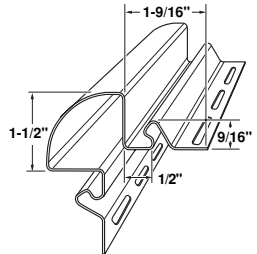

3-1/2" Lineal

Product Code: **LIN35**

Description

Length: 20'

Package

10 Pcs./Ctn.
26 Lbs./Ctn.

Color Availability

WHITE White (04)

LIGHT Ivory (N3), Sand (M4), Wicker (A7)

CLASSIC Khaki (N4)

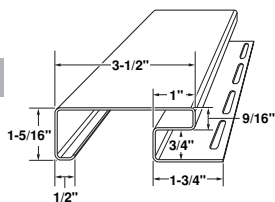

Lineal Starter

Product Code: **WCNCSS**

Description

Length: 12' 6"

Package

40 Pcs./Ctn.
40 Lbs./Ctn.

Color Availability

WHITE White (04)

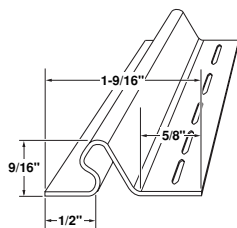

Recessed Lineal Starter

Product Code: **WCRSS**

Description

Length: 12' 6"

Package

40 Pcs./Ctn.
58 Lbs./Ctn.

Color Availability

WHITE White (04)

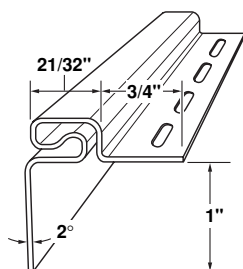

VINYL SIDING & SOFFIT ACCESSORIES

2-1/2" Wide Window Casing Trim 3/4"

Product Code: **WCT06**

Description

Length: 12' 6"

Package

20 Pcs./Ctn.
55 Lbs./Ctn.

Color Availability

- WHITE** White (04)
- LIGHT** Ivory (N3), Sand (M4), Wicker (A7)
- CLASSIC** Khaki (N4)

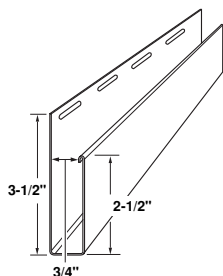

Bay Corner 3/4"

Product Code: **BAY0P06**

Description

Length: 10'

Package

10 Pcs./Ctn.

Color Availability

- WHITE** White (04)
- LIGHT** Ivory (N3), Sand (M4), Wicker (A7)
- CLASSIC** Khaki (N4)

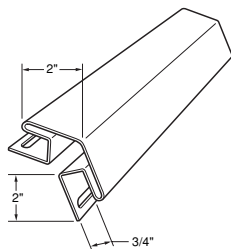

3" Snap-In Crown

Product Code: **SCROWN126**

Description

Length: 12' 6"

Package

20 Pcs./Ctn.
55 Lbs./Ctn.

Color Availability

- White** White (04)

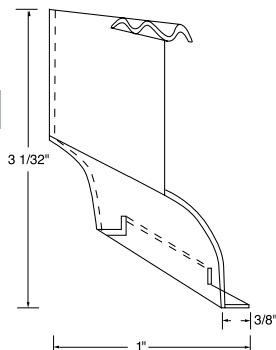

Snap-In Crown Mount

Product Code: **SCMNT126**

Description

Length: 12' 6"

Package

40 Pcs./Ctn.

46 Lbs./Ctn.

Color Availability

WHITE White (04)

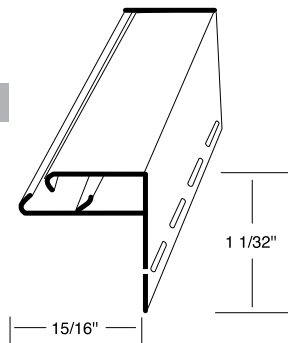

Snap-In Crown Mount with J-Channel

Product Code: **JSCMNT126**

Description

Length: 12' 6"

Package

40 Pcs./Ctn.

58 Lbs./Ctn.

Color Availability

WHITE White (04)

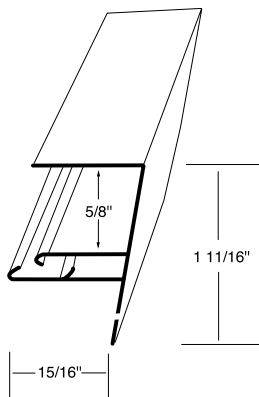

MOUNTING BLOCKS

Universal J-Block® Mounting Block

Product Code: **UNIBLOCK**

Description

1/2" to 1 1/4" adjustability
 Surface 7 3/16" x 8 3/16"
 Flange 7 1/2" x 8 1/2"
 Knockouts Round 4" diameter
 Rectangle: 2 3/8" x 3 3/4"

Package

10 2-piece Systems/Ctn.

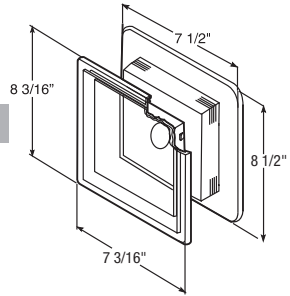

Color Availability

Available in more than 150 colors, including Paintable (11).

Uses: Light Fixtures.

Scalloped Universal J-Block® Mounting Block

Product Code: **UNIBLOCKSC**

Description

1/2" - 1 1/4" adjustability
 Surface: 7 3/16" x 8 3/16"
 Flange: 7 1/2" x 8 1/2"
 Can be used with insulated siding.

Package

Knockouts:
 Round: 3 11/16" diameter
 Rectangle: 2 3/8" x 3 3/4"
 4 Lbs./Ctn.
 10 2-piece systems/Ctn.

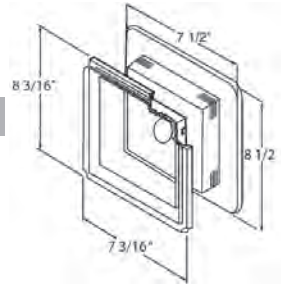

Color Availability

Available in more than 150 colors, including Paintable (11).

Uses: Light Fixtures, Electrical Receptacles, Water Faucets.

Coach Light Universal J-Block® Mounting Block

Product Code: **UNIBLOCKXL**

Description

1/2" - 1 1/4" adjustability
 Surface: 9" x 16"
 Flange: 11.67" x 18.71"
 Can be used with insulated siding.

Package

4 Pcs./Ctn.
 5 Lbs./Ctn.

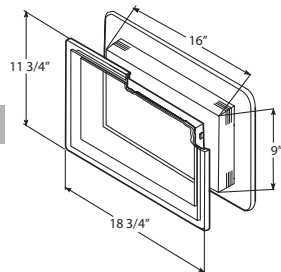

Color Availability

Available in more than 150 colors, including Paintable (11).

Uses: Coach Light Fixtures, Electrical Receptacles, House Numbers.

MOUNTING BLOCKS

Meter Base J-Block® Mounting Block

Product Code: **METER**

Description

Surface: 16 1/2" x 15 1/2"
Flange: 18 1/2" x 16 3/4"
1 1/2" to 1 1/4" adjustability

Package

5 Pcs./Ctn.
10 Lbs./Ctn.

Color Availability

Available in more than 150 colors, including Paintable (11).

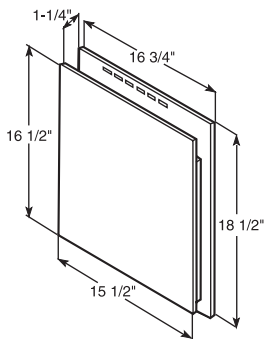

Uses: Hose Racks, Electrical Meter Bases. Can be used with siding.

Jumbo Meter J-Block® Mounting Block

Product Code: **METERLG**

Description

Surface: 20" x 24"
Flange: 21 1/2" x 24 1/2"
1/2" to 1 1/4" adjustability

Package

1 Pc./Ctn.
4 Lbs./Ctn.

Color Availability

Available in more than 150 colors, including Paintable (11).

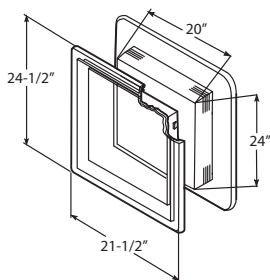

Uses: Hose Racks, Electrical Meter Bases. Can be used with siding.

Large J-Block® Mounting Block

Product Code: **FMBLOCK**

Description

Surface: 5" x 9"
Base: 4" x 9"
1/2" to 1 1/4" adjustability

Package

5 Pcs./Ctn.
3.5 Lbs./Ctn.

Color Availability

Available in more than 150 colors, including Paintable (11).

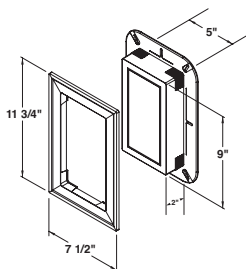

Uses: Light Fixtures, Mailboxes, House Numbers.

Note: Electrical box not included.

MOUNTING BLOCKS

Mini J-Block® Mounting Block

Product Code: **MBLOCK**

Description

Surface: 6" x 4 3/8"
Flange: 6 7/8" x 5 1/4"
Scored Knockouts:
Round: 1 1/8" Diameter
Rectangle: 2 3/8" x 3 3/4"

Package

10 Pcs./Ctn.
3 Lbs./Ctn.

Color Availability

Available in more than 150 colors, including Paintable (11).

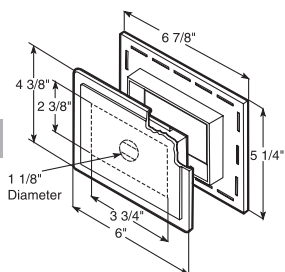

Uses: Doorbells, Electrical Outlets. Can be used with siding.

Split J-Block® Mounting Block

Product Code: **MBLOCKR**

Description

Surface: 5 1/4" x 7"
Flange: 5 7/8" x 7 1/2"
J-Channel I.D.: 3/4" adjusts to 1 1/4"

Package

10 Pcs./Ctn.
4 Lbs./Ctn.

Color Availability

Available in more than 150 colors, including Paintable (11).

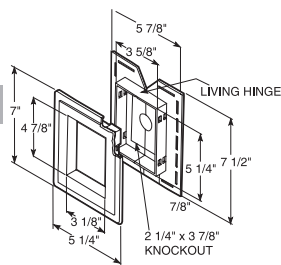

Uses: Faucets, Electrical Outlets. Hinged to fit around existing fixtures. Can be used with Siding.

MOUNTING BLOCKS

UL® Electrical Block

Product Code: **EBLOCK**

Description	Package
Siding Receiver: 3/4" - 1 1/2" in 1/8" increments	1 Ctn. 1 Lbs./Ctn.

Color Availability

Available in more than 150 colors, including Paintable (11).

Note: Each carton contains one electrical box and one mounting block.

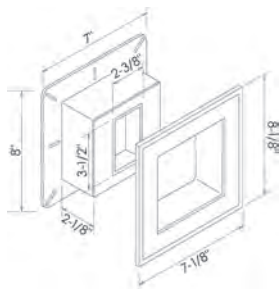

Large J-Block® Mounting Block with Electrical Box

Product Code: **FMEBLOCK**

Description	Package
Surface: 5" x 9" 1/2" to 1-1/4" adjustability	4 pcs./Ctn. 4.5 Lbs./Ctn.

Color Availability

Available in more than 150 colors, including Paintable (11).

Uses: Light Fixtures, Mailboxes, House Numbers.
Includes: UL approved black electrical box.

Note: Includes black electrical box.

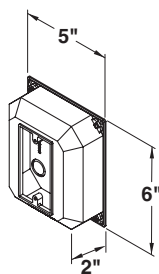
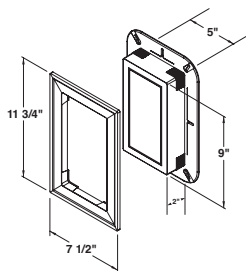

Electrical box included.

SURFACE MOUNTS

Square Surface Mount (Double 4" or Double 5")

Product Code: EZBLK040

Description

Surface: 6 3/4" x 6 3/4"
Projection: 3/4"
Scored Knockouts:
Round: 1" Diameter
Rectangle: 2 3/8" x 3 3/4"

Package

10 Pcs./Ctn.
4 Lbs./Ctn.

Color Availability

Available in more than 150 colors, including Paintable (11).

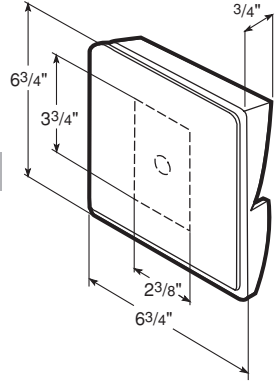

Note: Octagonal style (EZBLK080) also available.
Uses: Light fixtures, Electrical Outlet Receptacles, Water Faucets.

SURFACE MOUNTS

Square Surface Mount (Dutch Lap)

Product Code: EZBLK070

Description	Package
Surface Dimensions: 6 3/4" x 6 3/4"	10 Pcs./Ctn.
Projection: 3/4"	4 Lbs./Ctn.
Scored Knockouts:	
Round: 1" Diameter	
Rectangle: 2 3/8" x 3 3/4"	

Color Availability

Available in more than 150 colors, including Paintable (11).

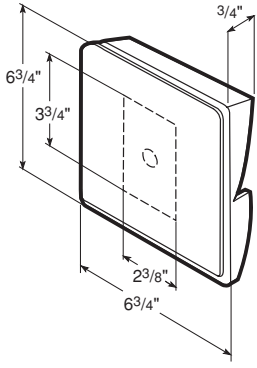

Note: Octagonal style (EZBLK110) also available.
 Uses: Light Fixtures, Electrical Outlet Receptacles, Water Faucets.

Octagon Surface Mount (Double 4" or Double 5")

Product Code: EZBLK080

Description	Package
Surface: 6 3/4" x 6 3/4"	10 Pcs./Ctn.
Projection: 3/4"	4 Lbs./Ctn.
Scored Knockouts:	
Round: 1" Diameter	Can be used with siding
Rectangle: 2 3/8" x 3 3/4"	

Color Availability

Available in more than 150 colors, including Paintable (11).

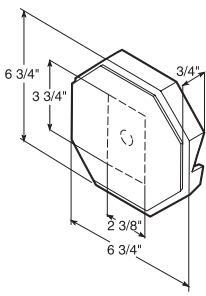

Note: Square Style (EZBLK040) also available.
 Uses: Light Fixtures, Electrical Outlet Receptacles, Water Faucets.

SURFACE MOUNTS

Octagon Surface Mount (Dutch Lap)

Product Code: EZBLK110

Description	Package
Surface: 6 3/4" x 6 3/4"	10 Pcs./Ctn.
Projection: 3/4"	4 Lbs./Ctn.
Scored Knockouts:	
Round: 1" Diameter	
Rectangle: 2 3/8" x 3 3/4"	

Color Availability

Available in more than 150 colors, including Paintable (11).

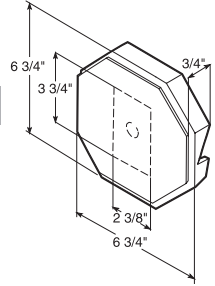

Note: Square Style (EZBLK070) also available.

Uses: Light Fixtures, Electrical Outlet Receptacles, Water Faucets.

Hooded Exhaust Vent System

Product Code: **DRYERHOOD**

Description	Package
Neutral Base	1 System/Ctn.
J-Channel I.D.: 3/4" adjusts to 1 1/4"	1 Lb./Ctn.

Color Availability

Available in more than 150 colors, including Paintable (11).

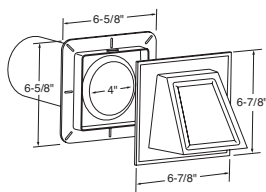

6" Dryer Hood

Product Code: **DRYERHOOD6**

Description	Package
Neutral Base	1 System/Ctn.
J-Channel I.D.: 1/2" adjusts to 1 1/4"	1 Lb./Ctn.

Color Availability

Available in more than 150 colors, including Paintable (11).

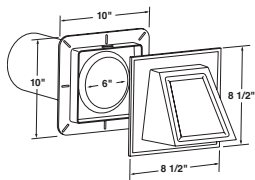

Foundation Vent

Product Code: **FVENT**

Description	Package
Net Free Area: 48 Sq. In.	10 Pcs./Ctn.
Surface: 8 3/4" x 17"	11 Lbs./Ctn.
Flange: 9 1/2" x 18 1/4"	
J-Channel I.D.: 3/4" adjusts to 1 1/4"	

Color Availability

Available in more than 150 colors, including Paintable (11).

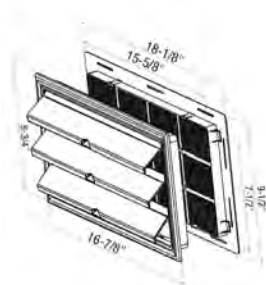

Air Vent

Product Code: **AIRVENT**

Description	Package
Net Free Area: 18 Sq. In.	5 Pcs./Ctn.
Surface: 7" x 11"	4 Lbs./Ctn.
Flange: 7 3/4" x 12 3/4"	
J-Channel I.D.: 3/4" adjusts to 1 1/4"	

Color Availability

Available in more than 150 colors, including Paintable (11).

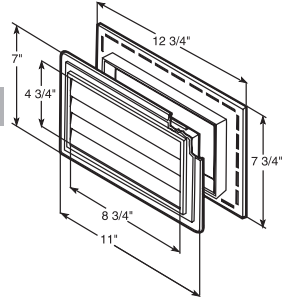

Louvered Exhaust Vent

Product Code: **EXVENT**

Description	Package
Surface: 7" x 7"	1 Pc./Ctn.
Flange: 8 1/2" x 7 1/2"	1 Lb./Ctn.
J-Channel I.D.: 3/4" adjusts to 1/4"	
Tube Length: 10"	
Tube Diameter: 4"	

Color Availability

Available in more than 150 colors, including Paintable (11).

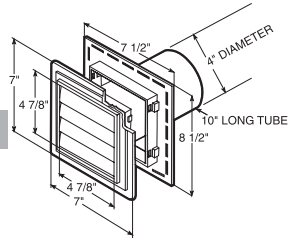

6" Louvered Exhaust Vent

Product Code: **EXVENT6**

Description	Package
Surface: 9" x 9"	1 System/Ctn.
Flange: 9.5" x 10.365"	1.2 Lbs./Ctn.
J-Channel I.D.: 3/4" adjusts to 1 1/4"	
Tube Length: 10"	
Tube Diameter: 6"	
Net Free Area: 17.6 Sq. In.	

Color Availability

Available in more than 150 colors, including Paintable (11).

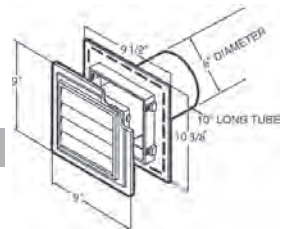

Can be used with insulated siding.

Intake Louver

Product Code: **INTAKE**

Description	Package
Size: 4 5/8" H x 4 5/8" W X 1 3/8" D	5 Pcs./Ctn. 1 Lb./Ctn.

Color Availability

Available in more than 150 colors, including Paintable (11).

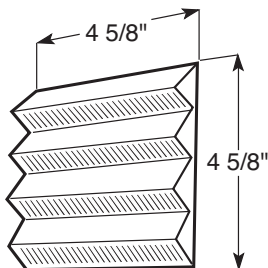

Note: For use with EXVENT (see page 35).

Soffit Intake/Exhaust Vent

Product Code: **INTVENT**

Description	Package
Siding Receiver: 5/8" – 1 1/4" in 1/8" increments Net Free Area: 12.3 Sq. In.	1 Pc./Ctn. 1 Lb./Ctn.

Color Availability

Available in more than 150 colors, including Paintable (11).

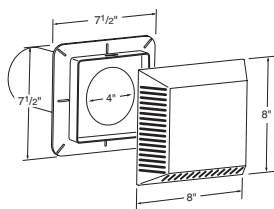

Fire Hazard: NEVER use exhaust vent w/ screen for dryer ventilation. Flammable buildup on screen can cause fire. Always use a vent that is specifically designed for dryer appliances.

Uses: Soffit Applications, Kitchen Exhaust, Bathroom Exhaust.

2-PIECE GABLE VENTS

18" Round Gable Vent

Product Code: RDGV18

Description

Siding Receiver: 3/4" – 1 1/4"
in 1/8" increments
Thickness: 1 1/2"
Net Free Area: 48.36 Sq. In.

Package

1 Pc./Ctn.
3 Lbs./Ctn.

Color Availability

Available in more than 150 colors, including Paintable (11).

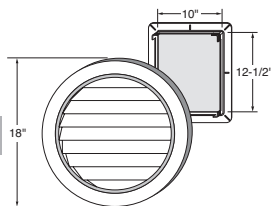

Note: Can be used with siding.

22" Round Gable Vent

Product Code: RDGV

Description

Siding Receiver: 3/4" – 1 1/4"
in 1/8" increments
Thickness: 1 1/2"
Net Free Area: 48.37 Sq. In.

5 Lbs./Ctn.
1 Pc./Ctn.

Color Availability

Available in more than 150 colors, including Paintable (11).

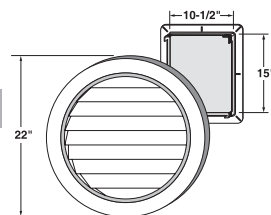

Note: Can be used with siding.

36" Round Gable Vent

Product Code: RDGV36

Description

Siding Receiver: 3/4" – 1 1/4"
in 1/8" increments
Thickness: 1 1/2"
Net Free Area: 277.1 Sq. In.

Package

1 Pc./Ctn.
9 Lbs./Ctn.

Color Availability

Available in more than 150 colors, including Paintable (11).

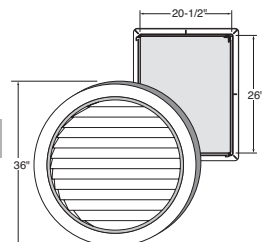

Note: Can be used with siding.

2-PIECE GABLE VENTS

18" Octagon Gable Vent

Product Code: **OCTGV18**

Description

Siding Receiver: 3/4" – 1 1/4"
in 1/8" increments
Thickness: 1 1/2"
Net Free Area: 49.72 Sq. In.

Package

1 Pc./Ctn.
3 Lbs./Ctn.

Color Availability

Available in more than 150 colors, including Paintable (11).

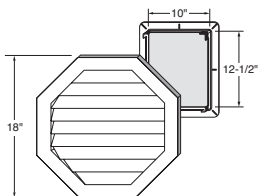

Note: Can be used with siding.

22" Octagonal Gable Vent

Product Code: **OCTGV**

Description

Siding Receiver: 3/4" – 1 1/4"
in 1/8" increments
Thickness: 1 1/2"
Net Free Area: 49.5 Sq. In.

Package

1 Pc./Ctn.
5 Lbs./Ctn.

Color Availability

Available in more than 150 colors, including Paintable (11).

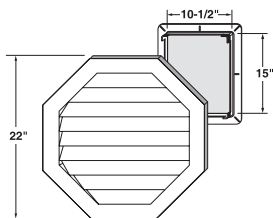

Note: Can be used with siding.

34" x 22" Half-Round Gable Vent

Product Code: **HRDGV**

Description

Siding Receiver: 3/4" – 1 1/4"
in 1/8" increments
Thickness: 1 1/2"
Net Free Area: 80.46 Sq. In.

Package

1 Pc./Ctn.
8 Lbs./Ctn.

Color Availability

Available in more than 150 colors, including Paintable (11).

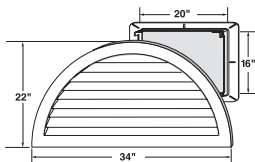

Note: Can be used with siding.

2-PIECE GABLE VENTS

14" x 22" Round Top Gable Vent

Product Code: **RDTOPGV14**

Description

Siding Receiver: 3/4" – 1 1/4"
in 1/8" increments
Thickness: 1 1/2"
Net Free Area: 53.17 Sq. In.

Package

1 Pc./Ctn.
3 Lbs./Ctn.

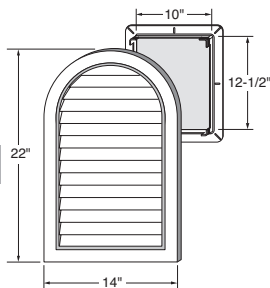

Color Availability

Available in more than 150 colors, including Paintable (11).

Note: Can be used with siding.

24" x 34" Round Top Gable Vent

Product Code: **RDTOPGV24**

Description

Siding Receiver: 3/4" – 1 1/4"
in 1/8" increments
Thickness: 1 1/2"
Net Free Area: 191 Sq. In.

Package

1 Pc./Ctn.
6 Lbs./Ctn.

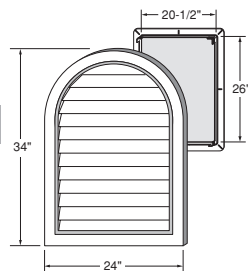

Color Availability

Available in more than 150 colors, including Paintable (11).

Note: Can be used with siding.

14" x 20" Rectangular Gable Vent

Product Code: **RECTGV**

Description

Siding Receiver: 3/4" – 1 1/4"
in 1/8" increments
Thickness: 1 1/2"
Net Free Area: 23.29 Sq. In.

Package

1 Pc./Ctn.
4 Lbs./Ctn.

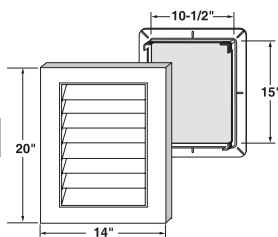

Color Availability

Available in more than 150 colors, including Paintable (11).

Note: Can be used with siding.

2-PIECE GABLE VENTS

18" x 24" Rectangular Gable Vent

Product Code: **RECTGV1824**

Description

Siding Receiver: 3/4" – 1 1/4"
in 1/8" increments
Thickness: 1 1/2"
Net Free Area: 92.88 Sq. In.

Package

1 Pc./Ctn.
6 Lbs./Ctn.

Color Availability

Available in more than 150 colors, including Paintable (11).

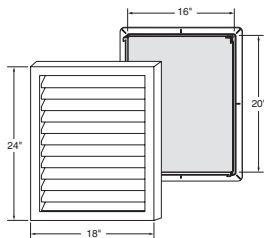

Note: Can be used with siding.

24" x 30" Rectangular Gable Vent

Product Code: **RECTGV2430**

Description

Siding Receiver: 3/4" – 1 1/4"
in 1/8" increments
Thickness: 1 1/2"
Net Free Area: 181.2 Sq. In.

Package

1 Pc./Ctn.
9 Lbs./Ctn.

Color Availability

Available in more than 150 colors, including Paintable (11).

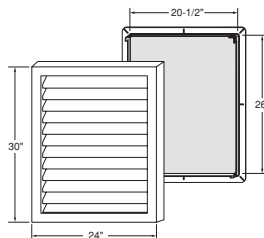

Note: Can be used with siding.

14" Square Gable Vent

Product Code: **SQGV1414**

Description

Siding Receiver: 3/4" – 1 1/4"
in 1/8" increments
Thickness: 1 1/2"
Net Free Area: 33.59 Sq. In.
Can be used with siding.

Package

1 Pc./Ctn.
3 Lbs./Ctn.

Color Availability

Available in more than 150 colors, including Paintable (11).

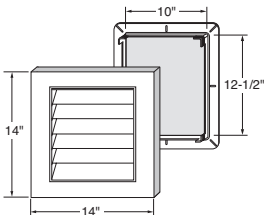

Note: Can be used with siding.

BOARD & BATTEN SHUTTERS

4 Board — Closed Arched Top

Description	Package
Nominal 14" wide High-Density Copolymer Baked-On Acrylic Finish	1 Pr./Ctn.

Color Availability
White (11), Black (33), Blackwatch Green (99), Blue (41), Brown (59), Coastal Blue (BLU), Dark Berry (LJ), Dark Navy (95), Dark Spruce (56), Green (55), Gray (16), Pebblestone Clay (52), Peppercorn (PE), Red (38), Sand Dollar (CRM), Spanish Moss (93), Terra Brown (SL), Vineyard Red (SK), Winestone (58)

Product Availability		
Product Code	Length	Lbs./Ctn.
BARCH41	41"	7 Lbs./Ctn.
BARCH43	43"	7.5 Lbs./Ctn.
BARCH57	57"	9.5 Lbs./Ctn.
BARCH61	61"	10 Lbs./Ctn.
BARCH65	65"	10.5 Lbs./Ctn.
BARCH71	71"	11.5 Lbs./Ctn.
BARCH73	73"	12 Lbs./Ctn.
BARCH77	77"	12.5 Lbs./Ctn.
BARCH85	85"	13 Lbs./Ctn.



3 Board Open

Description	Package
Nominal 12" Wide High-Density Copolymer Baked-On Acrylic Finish	1 Pr./Ctn.

Color Availability
White (11), Black (33), Blackwatch Green (99), Blue (41), Brown (59), Coastal Blue (BLU), Dark Berry (LJ), Dark Navy (95), Dark Spruce (56), Green (55), Gray (16), Pebblestone Clay (52), Peppercorn (PE) Red (38), Sand Dollar (CRM), Spanish Moss (93), Terra Brown (SL), Vineyard Red (SK), Winestone (58)

Product Availability		
Product Code	Length	Lbs./Ctn.
VIN301231	31"	4.5 Lbs./Ctn.
VIN301235	35"	5 Lbs./Ctn.
VIN301239	39"	5 Lbs./Ctn.
VIN301243	43"	6 Lbs./Ctn.
VIN301247	47"	6 Lbs./Ctn.
VIN301251	51"	6.5 Lbs./Ctn.
VIN301255	55"	7.5 Lbs./Ctn.
VIN301259	59"	8 Lbs./Ctn.
VIN301263	63"	8 Lbs./Ctn.
VIN301267	67"	8.5 Lbs./Ctn.
VIN301271	71"	9 Lbs./Ctn.
VIN301275	75"	9.5 Lbs./Ctn.
VIN301281	81"	10 Lbs./Ctn.

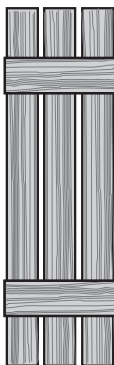

Note: All shutter cartons include steel mounting screws. Shutter touch-up paint available. Lengths up to 51" have 2 cross boards, lengths 55" and larger have 3 cross boards.

BOARD & BATTEN SHUTTERS

3 Board Closed

Description

Nominal 11" Wide
High-Density Copolymer
Baked-On Acrylic Finish

Package

1 Pr./Ctn.

Color Availability

White (11), Black (33), Blackwatch Green (99), Blue (41), Brown (59), Coastal Blue (BLU), Dark Berry (LJ), Dark Navy (95), Dark Spruce (56), Green (55), Gray (16), Pebblestone Clay (52), Peppercorn (PE), Red (38), Sand Dollar (CRM), Spanish Moss (93), Terra Brown (SL), Vineyard Red (SK), Winestone (58)

Product Availability

Product Code	Length	Lbs./Ctn.
VIN3C1131	31"	4.5 Lbs./Ctn.
VIN3C1135	35"	5 Lbs./Ctn.
VIN3C1139	39"	5 Lbs./Ctn.
VIN3C1143	43"	5.5 Lbs./Ctn.
VIN3C1147	47"	6 Lbs./Ctn.
VIN3C1151	51"	6 Lbs./Ctn.
VIN3C1155	55"	7 Lbs./Ctn.
VIN3C1159	59"	7.5 Lbs./Ctn.
VIN3C1163	63"	8 Lbs./Ctn.
VIN3C1167	67"	8.5 Lbs./Ctn.
VIN3C1171	71"	9 Lbs./Ctn.
VIN3C1175	75"	9 Lbs./Ctn.
VIN3C1181	81"	10 Lbs./Ctn.



Note: All shutter cartons include steel mounting screws. Shutter touch-up paint available. Lengths up to 51" have 2 cross boards, lengths 55" and larger have 3 cross boards.

BOARD & BATTEN SHUTTERS

4 Board Open

Description	Package
Nominal 16" Wide High-Density Copolymer Baked-On Acrylic Finish	1 Pr./Ctn.

Color Availability

White (11), Black (33), Blackwatch Green (99), Blue (41), Brown (59), Coastal Blue (BLU), Dark Berry (IJ), Dark Navy (95), Dark Spruce (56), Green (55), Gray (16), Pebblestone Clay (52), Peppercorn (PE), Red (38), Sand Dollar (CRM), Spanish Moss (93), Terra Brown (SL), Vineyard Red (SK), Winestone (58)

Product Availability

Product Code	Length	Lbs./Ctn.
VIN401631	31"	6 Lbs./Ctn.
VIN401635	35"	6.5 Lbs./Ctn.
VIN401639	39"	7 Lbs./Ctn.
VIN401643	43"	7.5 Lbs./Ctn.
VIN401647	47"	8 Lbs./Ctn.
VIN401651	51"	8.5 Lbs./Ctn.
VIN401655	55"	10 Lbs./Ctn.
VIN401659	59"	10.5 Lbs./Ctn.
VIN401663	63"	11 Lbs./Ctn.
VIN401667	67"	11.5 Lbs./Ctn.
VIN401671	71"	12 Lbs./Ctn.
VIN401675	75"	12.5 Lbs./Ctn.
VIN401681	81"	13 Lbs./Ctn.

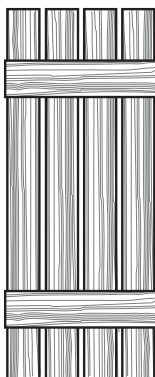

Note: All shutter cartons include steel mounting screws. Shutter touch-up paint available. Lengths up to 51" have 2 cross boards, lengths 55" and larger have 3 cross boards.

BOARD & BATTEN SHUTTERS

4 Board Closed

Description	Package
Nominal 15" Wide High-Density Copolymer Baked-On Acrylic Finish	1 Pr./Ctn.

Color Availability

White (11), Black (33), Blackwatch Green (99), Blue (41), Brown (59), Coastal Blue (BLU), Dark Berry (LJ), Dark Navy (95), Dark Spruce (56), Green (55), Gray (16), Pebblestone Clay (52), Peppercorn (PE), Red (38), Sand Dollar (CRM), Spanish Moss (93), Terra Brown (SL), Vineyard Red (SK), Winestone (58)

Product Availability

Product Code	Length	Lbs./Ctn.
VIN4C1531	31"	6 Lbs./Ctn.
VIN4C1535	35"	6.5 Lbs./Ctn.
VIN4C1539	39"	7 Lbs./Ctn.
VIN4C1543	43"	7.5 Lbs./Ctn.
VIN4C1547	47"	8 Lbs./Ctn.
VIN4C1551	51"	8.5 Lbs./Ctn.
VIN4C1555	55"	10 Lbs./Ctn.
VIN4C1559	59"	10 Lbs./Ctn.
VIN4C1563	63"	10.5 Lbs./Ctn.
VIN4C1567	67"	11 Lbs./Ctn.
VIN4C1571	71"	11.5 Lbs./Ctn.
VIN4C1575	75"	12 Lbs./Ctn.
VIN4C1581	81"	13 Lbs./Ctn.



Note: All shutter cartons include steel mounting screws. Shutter touch-up paint available. Lengths up to 51" have 2 cross boards, lengths 55" and larger have 3 cross boards.

STANDARD 12" RAISED PANEL SHUTTERS

Standard Raised Panel Shutters

Description	Package
Nominal 12" Wide High-Density Copolymer Baked-On Acrylic Finish	1 Pr./Ctn.

Color Availability

White (11), Black (33), Blackwatch Green (99), Blue (41), Brown (59), Coastal Blue (BLU), Dark Berry (IJ), Dark Navy (95), Dark Spruce (56), Green (55), Gray (16), Pebblestone Clay (52), Peppercorn (PE), Red (38), Sand Dollar (CRM), Spanish Moss (93), Terra Brown (SL), Vineyard Red (SK), Winestone (58)

Product Availability

Product Code	Length	Lbs./Ctn.
VINRP1227	27"	6 Lbs./Ctn.
VINRP1231	31"	7 Lbs./Ctn.
VINRP1235	35"	8 Lbs./Ctn.
VINRP1239	39"	8 Lbs./Ctn.
VINRP1243	43"	9 Lbs./Ctn.
VINRP1247	47"	10 Lbs./Ctn.
VINRP1251	51"	11 Lbs./Ctn.
VINRP1255	55"	12 Lbs./Ctn.
VINRP1259	59"	12 Lbs./Ctn.
VINRP1263	63"	13 Lbs./Ctn.
VINRP1267	67"	13 Lbs./Ctn.
VINRP1271	71"	15 Lbs./Ctn.

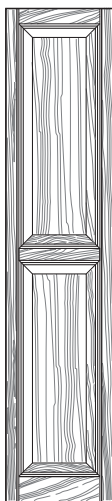

Regular Style

Note: All shutter cartons include steel mounting screws. Shutter touch-up paint available.

STANDARD 12" OPEN LOUVERED SHUTTERS

Standard Open Louvered Shutters

Description

Nominal 12" Wide
High-Density Copolymer
Baked-On Acrylic Finish

Package

1 Pr./Ctn.

Color Availability

White (11), Black (33), Blackwatch Green (99), Blue (41), Brown (59), Coastal Blue (BLU), Dark Berry (LJ), Dark Navy (95), Dark Spruce (56), Green (55), Gray (16), Pebblestone Clay (52), Peppercorn (PE), Red (38), Sand Dollar (CRM), Spanish Moss (93), Terra Brown (SL), Vineyard Red (SK), Winestone (58)

Product Availability

Product Code	Length	Lbs./Ctn.
VINLV1255	55"	12 Lbs./Ctn.
VINLV1259	59"	12 Lbs./Ctn.

Note: All shutter cartons include steel mounting screws. Shutter touch-up paint available.



Regular Style

STANDARD 15" RAISED PANEL SHUTTERS

Standard Raised Panel Shutters

Description	Package
Nominal 15" Wide High-Density Copolymer Baked-On Acrylic Finish	1 Pr./Ctn.

Color Availability

White (11), Black (33), Blackwatch Green (99), Blue (41), Brown (59), Coastal Blue (BLU), Dark Berry (IJ), Dark Navy (95), Dark Spruce (56), Green (55), Gray (16), Pebblestone Clay (52), Peppercorn (PE), Red (38), Sand Dollar (CRM), Spanish Moss (93), Terra Brown (SL), Vineyard Red (SK), Winestone (58)

Product Availability

Product Code	Length	Lbs./Ctn.
VINRP1531	31"	6 Lbs./Ctn.
VINRP1535	35"	7 Lbs./Ctn.
VINRP1539	39"	8 Lbs./Ctn.
VINRP1543	43"	9 Lbs./Ctn.
VINRP1547	47"	9 Lbs./Ctn.
VINRP1551	51"	10 Lbs./Ctn.
VINRP1555	55"	10 Lbs./Ctn.
VINRP1559	59"	11 Lbs./Ctn.
VINRP1563	63"	12 Lbs./Ctn.
VINRP1567	67"	13 Lbs./Ctn.
VINRP1567C	67"*	13 Lbs./Ctn.
VINRP1571	71"	13 Lbs./Ctn.
VINRP1575	75"	14 Lbs./Ctn.
VINRP1581	81"	15 Lbs./Ctn.

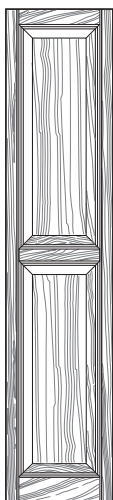

Regular Style
*Cottage Style (not shown)

Note: All shutter cartons include 3" painted steel mounting screws & shutter plugs.
Shutter touch-up paint available.

STANDARD 15" OPEN LOUVERED SHUTTERS

Standard Open Louvered Shutters

Description

Nominal 15" Wide
High-Density Copolymer
Baked-On Acrylic Finish

Package

1 Pr./Ctn.

Color Availability

White (11), Black (33), Blackwatch Green (99), Blue (41), Brown (59), Coastal Blue (BLU), Dark Berry (LJ), Dark Navy (95), Dark Spruce (56), Green (55), Gray (16), Pebblestone Clay (52), Peppercorn (PE), Red (38), Sand Dollar (CRM), Spanish Moss (93), Terra Brown (SL), Vineyard Red (SK), Winestone (58)

Product Availability

Product Code	Length	Lbs./Ctn.
VINLV1525	27"	6 Lbs./Ctn.
VINLV1531	31"	7 Lbs./Ctn.
VINLV1535	35"	8 Lbs./Ctn.
VINLV1539	39"	8 Lbs./Ctn.
VINLV1543	43"	9 Lbs./Ctn.
VINLV1547	47"	10 Lbs./Ctn.
VINLV1551	51"	11 Lbs./Ctn.
VINLV1555	55"	12 Lbs./Ctn.
VINLV1559	59"	12 Lbs./Ctn.
VINLV1563	63"	13 Lbs./Ctn.
VINLV1567	67"	13 Lbs./Ctn.
VINLV1567C*	67"	15 Lbs./Ctn.
VINLV1571	71"	15 Lbs./Ctn.
VINLV1575	75"	15 Lbs./Ctn.
VINLV1581	81"	15 Lbs./Ctn.



Regular Style

*Cottage Style (not shown)

Note: All shutter cartons include 3" painted steel mounting screws & shutter plugs.
Shutter touch-up paint available.

STANDARD 15" RAISED PANEL SHUTTERS

Raised Panel Arch Top

Product Code: ARCH15RP

Description	Package
Nominal 15" Wide	1 Pr./Ctn.
High-Density Copolymer	3 Lbs./Ctn.
Baked-on Acrylic Finish	

Color Availability

White (11), Black (33), Blackwatch Green (99), Blue (41), Brown (59), Coastal Blue (BLU), Dark Berry (JJ), Dark Navy (95), Dark Spruce (56), Green (55), Gray (16), Pebblestone Clay (52), Peppercorn (PE), Red (38), Sand Dollar (CRM), Spanish Moss (93), Terra Brown (SL), Vineyard Red (SK), Winestone (58)

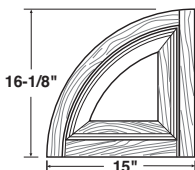

Note: Applies to 15" width shutters only. Shutter touch-up paint available.

Raised Panel Transom Top

Product Code: TRANRP15

Description	Package
Nominal 15" Wide	1 Pr./Ctn.
High-Density Copolymer	3 Lbs./Ctn.
Baked-on Acrylic Finish	

Color Availability

White (11), Black (33), Blackwatch Green (99), Blue (41), Brown (59), Coastal Blue (BLU), Dark Berry (JJ), Dark Navy (95), Dark Spruce (56), Green (55), Gray (16), Pebblestone Clay (52), Peppercorn (PE), Red (38), Sand Dollar (CRM), Spanish Moss (93), Terra Brown (SL), Vineyard Red (SK), Winestone (58)

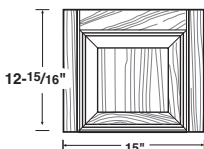

Note: Applies to 15" width shutters only. Shutter touch-up paint available.

STANDARD 15" OPEN LOUVERED SHUTTERS

Open Louvered Arch Top

Product Code: ARCH15LV

Description	Package
Nominal 15" Wide	1 Pr./Ctn.
High-Density Copolymer	3 Lbs./Ctn.
Baked-On Acrylic Finish	

Color Availability

White (11), Black (33), Blackwatch Green (99), Blue (41), Brown (59), Coastal Blue (BLU), Dark Berry (JJ), Dark Navy (95), Dark Spruce (56), Green (55), Gray (16), Pebblestone Clay (52), Peppercorn (PE), Red (38), Sand Dollar (CRM), Spanish Moss (93), Terra Brown (SL), Vineyard Red (SK), Winestone (58)

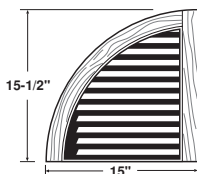

Note: Applies to 15" width shutters only. Shutter touch-up paint available.

STANDARD SHUTTERS ACCESSORIES

Fastener

Product Code: **SHUTTRPLUG**

Description

1/4" x 2 5/8"

Package

12 Pcs./Pkg.



Painted Steel Replacement Screws

Product Code: **VINITT**

Description

3/16" x 3"

Package

4 Pcs./Pkg.
.10 Lbs./Pkg.



Color Availability

White (11), Dark Navy (95), Green (55), Vineyard Red (SK), Black (33), Coastal Blue (BLU), Dark Berry (IJ), Pebblestone Clay (52), Peppercorn (PE), Winestone (58), Blackwatch Green (99), Dark Spruce (56), Red (38), Sand Dollar (CRM), Spanish Moss (93), Brown (59), Gray (16), Terra Brown (SL)

Shutter Clips & Anchors

Product Code: **SHTCLP12**

Description

Mill Finish

Package

12 Pcs./Pkg.



Hooks & Hinges

Product Code: **SHOOK**

Description

Black

Package

Includes:
(4) Hinges, (2) S-hooks, and
(10) screws.

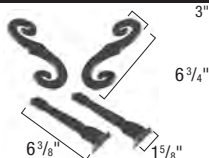

Touch-Up Paint

Product Code: **SHUTPAINT**

Description

Bottled with Brush

Package

1 oz./Plastic Bottle
1/Ctn.



Color Availability

White (11), Black (33), Blackwatch Green (99), Blue (41), Brown (59), Coastal Blue (BLU), Dark Berry (IJ), Dark Navy (95), Dark Spruce (56), Green (55), Gray (16), Pebblestone Clay (52), Peppercorn (PE), Red (38), Sand Dollar (CRM), Spanish Moss (93), Terra Brown (SL), Vineyard Red (SK), Winestone (58)

CUSTOM SHUTTERS

Custom Raised Panel Shutters

Description	Package
Nominal 12" or 15" Wide High-Density Copolymer Baked-On Acrylic Finish	1 Pr./Ctn.

CUSTOM SHUTTERS ARE BUILT TO ORDER AND WILL SHIP IN THREE (3) WORKING DAYS. FREIGHT IS PRE-PAID ON 1 CARTON OF CUSTOM SHUTTERS

Color Availability

White (11), Black (33), Blackwatch Green (99), Blue (41), Brown (59), Coastal Blue (BLU), ark Berry (IJ), Dark Navy (95), Dark Spruce (56), Green (55), Gray (16), Pebblestone Clay (52), Peppercorn (PE), Red (38), Sand Dollar (CRM), Spanish Moss (93), Terra Brown (SL), Vineyard Red (SK), Winestone (58)

Product Availability

Available in lengths from 18" to 96" in 1" increments

Product Code Example: CRP1530

CRP1530 = CRP + Width + Length

Custom Raised Panel = CRP, Width = 15, Length = 30

Note: All shutter cartons include 3" painted steel mounting screws & shutter plugs.
Shutter touch-up paint available.

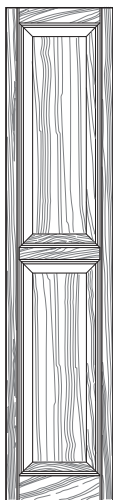

Regular Style

Custom Open Louvered Shutters

Description	Package
Nominal 9", 12", or 15" Wide High-Density Copolymer Baked-On Acrylic Finish	1 Pr./Ctn.

CUSTOM SHUTTERS ARE BUILT TO ORDER AND WILL SHIP IN THREE (3) WORKING DAYS. FREIGHT IS PRE-PAID ON 1 CARTON OF CUSTOM SHUTTERS

Color Availability

White (11), Black (33), Blackwatch Green (99), Blue (41), Brown (59), Coastal Blue (BLU), Dark Berry (IJ), Dark Navy (95), Dark Spruce (56), Green (55), Gray (16), Pebblestone Clay (52), Peppercorn (PE), Red (38), Sand Dollar (CRM), Spanish Moss (93), Terra Brown (SL), Vineyard Red (SK), Winestone (58)

Product Availability

Available in lengths from 18" to 96" in 1" increments

Product Code Example: CLV1530

CRP1530 = CLV + Width + Length

Custom Louvered Panel = CLV, Width = 15, Length = 30

Note: All shutter cartons include 3" painted steel mounting screws & shutter plugs.
Shutter touch-up paint available.



Regular Style

Window Mantel

Product Code: **PLWINMTL36**

Description

Height: 7 1/4"
Length: 36"

Package

1 Pc./Pkg.
6 Lbs./Ctn.

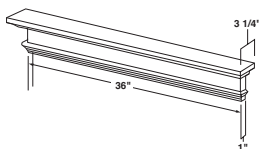

Color Availability

(11) Paintable version available.

Window Mantel

Product Code: **PLWINMTL40**

Description

Height: 7 1/4"
Length: 40"

Package

1 Pc./Pkg.
7 Lbs./Ctn.

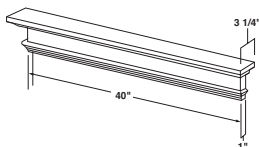

Color Availability

(11) Paintable version available.

Window Mantel

Product Code: **PLWINMTL44**

Description

Height: 7 1/4"
Length: 44"

Package

1 Pc./Pkg.
7 Lbs./Ctn.

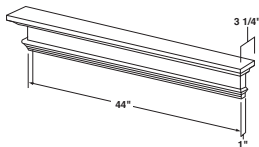

Color Availability

(11) Paintable version available.

WINDOW MANTELS

Window Mantel with Dentil Trim

Product Code: DTWINMTL36

Description	Package
Height: 7 1/4" Length: 36"	1 Pc./Pkg. 6 Lbs./Ctn.

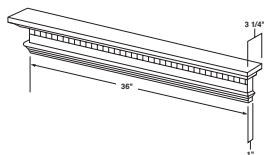

Color Availability

(11) Paintable version available.

Window Mantel with Dentil Trim

Product Code: DTWINMTL40

Description	Package
Height: 7 1/4" Length: 40"	1 Pc./Pkg. 7 Lbs./Ctn.

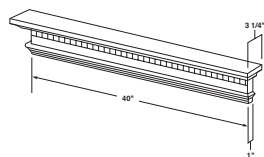

Color Availability

(11) Paintable version available.

Window Mantel with Dentil Trim

Product Code: DTWINMTL44

Description	Package
Height: 7 1/4" Length: 44"	1 Pc./Pkg. 7 Lbs./Ctn.

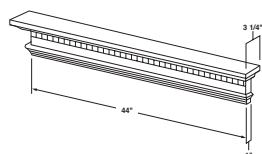

Color Availability

(11) Paintable version available.

Keystone

Product Code: KEYSTONE

Description	Package
Height: 8 3/4" Length: 7 3/4"	1 Pc./Ctn. 1 Lb./Ctn.

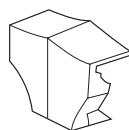

Color Availability

(11) Paintable version available.

Endcap

Product Code: ENDCAP

Description	Package
Includes styrene adhesive	1 Pc./Ctn. 1 Lb./Ctn.

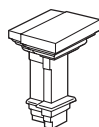

Color Availability

(11) Paintable version available.

Mantel System

Product Code: **MANTEL120**

Description	Package
Mantel: Face Height: 7 3/8" Length: 120"	1 Mantel System/Ctn. 15 Lbs./Ctn.
Plain Cover Strip: Height: 1" Thickness: .139" Length: 120"	Mantel System Includes: 1 – Mantel (120") 1 – Plain Cover Strip (120") 16 – (8) Anchors (8) Screws/Washers

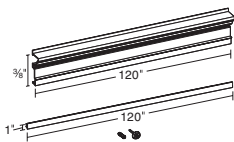

Color Availability

(04) Paintable version available.

Dentil Strip

Product Code: **DENTILSTP**

Description	Package
Height: 1" Length: 60"	2 Pcs./Pkg. 2 Lbs./Ctn.

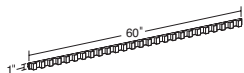

Color Availability

(11) Paintable version available.

Keystone for Mantel System

Product Code: **KEYSTN**

Description	Package
Height: 7 1/2" Top Width: 7" Bottom Width: 4 3/4"	1 Pc./Pkg. 1 Lbs./Ctn. Includes Mounting Hardware

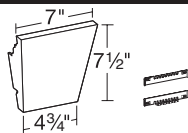

Color Availability

(04) Paintable version available.

Siding Endcaps - for 120" Mantel System

Product Code: **SDGENDCAP**

Description	Package
Height: 7 3/8" Width: 3 1/4"	2 Pcs./Pkg. 2 Lbs./Ctn. Includes styrene adhesive

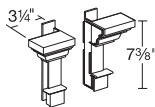

Color Availability

(04) Paintable version available.

Brick Endcaps - for 120" Mantel System

Product Code: **BRKENDCAP**

Description	Package
Height: 7 3/8" Width: 3 1/4"	2 Pcs./Pkg. 2 Lbs./Ctn. Includes styrene adhesive

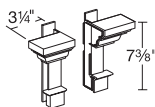

Color Availability

(04) Paintable version available.

DOOR SURROUND SYSTEMS

Pediment Set

Product Code: **PEDIMENTST**

Description	Package
Height: 12 3/4" Length: 18 1/2"	1 Pc./Pkg. 8 Lbs./Ctn.

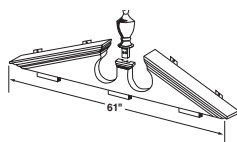

Color Availability

(11) Paintable version available.

Door Surround Mantel

Product Code: **MANTEL**

Description	Package
Length: 58"	1 Pc./Pkg. 8 Lbs./Ctn.

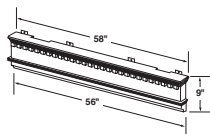

Color Availability

(11) Paintable version available.

Door Mantel Overlay

Product Code: **MANTELOVLY**

Description	Package
Length: 10 1/2"	6 Pcs./Pkg. 6 Lbs./Ctn.

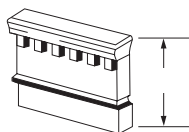

Color Availability

(11) Paintable version available.

Pilaster Cap

Product Code: **TOPCAP**

Description	Package
	1 Pc./Pkg. 1 Lb./Ctn.

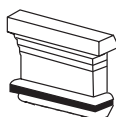

Color Availability

(11) Paintable version available.

Pilaster Base

Product Code: **BASECAP**

Description	Package
	1 Pc./Pkg. 1 Lb./Ctn.

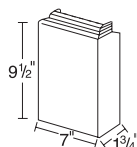

Color Availability

(11) Paintable version available.

Pilaster Set

Product Code: **PILASTER96**

Description	Package
Height: 96"	1 Pr./Ctn.
Pilaster Set Includes:	15 Lbs./Ctn.
2 Pilasters	
6 Mounting Clips	
2 Pilaster Caps	
2 Pilaster Bases	
Width: 7 1/2"	

Color Availability

(11) Paintable version available.



Pilaster Set

Product Code: **PILASTER144**

Description	Package
Height: 14"	1 Pr./Ctn.
Pilaster Set Includes:	20 Lbs./Ctn.
2 Pilasters	
6 Mounting Clips	
2 Pilaster Caps	
2 Pilaster Bases	
Width: 7 1/2"	

Color Availability

(11) Paintable version available.



Brand	Color Name	Color
ABTCO	Almond	ET
ABTCO	Antique Ivory	FL
ABTCO	Brick	GJ
ABTCO	Charcoal	090
ABTCO	Cherry*	S7
ABTCO	Classic Linen	44
ABTCO	Clay	EY
ABTCO	Cobalt	T8
ABTCO	Cobblestone	FP
ABTCO	Cypress*	DD
ABTCO	Evergreen	GM
ABTCO	Gray	FM
ABTCO	Heritage Gray	02
ABTCO	Khaki	52
ABTCO	Natural Oak*	BM
ABTCO	Pecan	100
ABTCO	Prairie Wheat	30
ABTCO	River Rock*	GI
ABTCO	Sage	JE
ABTCO	Sand	EX
ABTCO	Sandstone	22
ABTCO	Slate	FN
ABTCO	Slate Blue	46
ABTCO	Tan	39
ABTCO	Umber	148 or G0
ABTCO	Vermont Maple*	JC
ABTCO	Weathered Wood*	EJ
ABTCO	White	04
ALSIDE	Acorn*	S7
ALSIDE	Adobe Cream	EV
ALSIDE	Antique Parchment	31
ALSIDE	Arbor	SS
ALSIDE	Autumn Red	290

* Recommended solid color match for a variegated color.

Brand	Color Name	Color
ALSIDE	Balsam*	EY
ALSIDE	Canyon Drift	100
ALSIDE	Cape Cod Gray	EJ
ALSIDE	Coastal Sage	510
ALSIDE	Colonial Ivory	ET
ALSIDE	Deep Moss	GM
ALSIDE	Flagstone*	EA
ALSIDE	Glacier White	04
ALSIDE	Harbor Blue	390
ALSIDE	Hawthorne*	100
ALSIDE	Heather	K5
ALSIDE	Hemlock*	E4
ALSIDE	Ivy	JF
ALSIDE	Juniper Ridge	JE
ALSIDE	London Brown	BS
ALSIDE	Maple	JD
ALSIDE	Monterey Sand	22
ALSIDE	Mystic Blue	ND
ALSIDE	Natural Linen	44
ALSIDE	Platinum Gray	EH
ALSIDE	Sand Dune*	FP
ALSIDE	Silver Moss	18
ALSIDE	Slate	EA
ALSIDE	Somerset Wheat	GB
ALSIDE	Storm	BH
ALSIDE	Tuscan Clay	PC
ALSIDE	Vintage Wicker	FJ
ALSIDE	Walnut	JH
AMCRAFT	Almond	53
AMCRAFT	Classic Cream	30
AMCRAFT	Deep Granite	090
AMCRAFT	English Wedgewood	390
AMCRAFT	Pebblestone Clay	52

Brand	Color Name	Color
AMCRAFT	Quiet Willow	170
AMCRAFT	Rugged Canyon	100
AMCRAFT	Scottish Thistle	510
AMCRAFT	Silver Grey	02
AMCRAFT	Victorian Grey	36
AMCRAFT	White	04
AMCRAFT	Wicker	A7
CELLWOOD	Almond	53
CELLWOOD	Alpine Green	IG
CELLWOOD	Autumn Tan	39
CELLWOOD	Beige	30
CELLWOOD	Canyon	100
CELLWOOD	Chestnut*	E9
CELLWOOD	French Silk	210
CELLWOOD	Granite	090
CELLWOOD	Hickory*	E7
CELLWOOD	Ivory	31
CELLWOOD	Juniper*	E4
CELLWOOD	Khaki	52
CELLWOOD	Mist	18
CELLWOOD	Musket Brown	N5
CELLWOOD	Nantucket Gray	35
CELLWOOD	Olive	511
CELLWOOD	Patriot Blue	IB
CELLWOOD	Pewter	36
CELLWOOD	Russet Red	290
CELLWOOD	Sand	22
CELLWOOD	Shadow	144
CELLWOOD	Slate Blue	17
CELLWOOD	Spruce Blue*	E6
CELLWOOD	Stone Gray	02
CELLWOOD	Suede	IF
CELLWOOD	Sunrise Yellow	10

* Recommended solid color match for a variegated color.

Brand	Color Name	Color
CELLWOOD	Thistle	510
CELLWOOD	Weathered Ash*	52
CELLWOOD	Wedgewood	390
CELLWOOD	White	04
CELLWOOD	Wicker	A7
CELLWOOD	Willow	170
CERTAINEED/WOLVERINE	Arbor Blend*	E4
CERTAINEED/WOLVERINE	Arctic Blend*	E6
CERTAINEED/WOLVERINE	Autumn Red	290
CERTAINEED/WOLVERINE	Autumn Yellow	10
CERTAINEED/WOLVERINE	Barn Red	290
CERTAINEED/WOLVERINE	Bermuda Blue	FK
CERTAINEED/WOLVERINE	Buckskin	GK
CERTAINEED/WOLVERINE	Canyon Blend*	EX
CERTAINEED/WOLVERINE	Castle Stone	EI
CERTAINEED/WOLVERINE	Cedar Blend*	E9
CERTAINEED/WOLVERINE	Charcoal Gray	E6
CERTAINEED/WOLVERINE	Colonial White	PW
CERTAINEED/WOLVERINE	Coral	RP
CERTAINEED/WOLVERINE	Cypress	JE
CERTAINEED/WOLVERINE	Desert Tan	53
CERTAINEED/WOLVERINE	Driftwood Blend*	EA
CERTAINEED/WOLVERINE	Flagstone	BU
CERTAINEED/WOLVERINE	Forest	GM
CERTAINEED/WOLVERINE	Frontier Blend*	FQ
CERTAINEED/WOLVERINE	Glacier Blend*	A4
CERTAINEED/WOLVERINE	Granite Gray	35
CERTAINEED/WOLVERINE	Green Tea	18
CERTAINEED/WOLVERINE	Hearthstone	100
CERTAINEED/WOLVERINE	Heritage Cream	30
CERTAINEED/WOLVERINE	Herringbone	BI
CERTAINEED/WOLVERINE	Ivy Green	GG
CERTAINEED/WOLVERINE	Linen	22

Brand	Color Name	Color
CERTAINEED/WOLVERINE	Light Maple	ET
CERTAINEED/WOLVERINE	Meadow Blend*	22
CERTAINEED/WOLVERINE	Mint	RG
CERTAINEED/WOLVERINE	Mountain Cedar	SP
CERTAINEED/WOLVERINE	Natural Clay	PC
CERTAINEED/WOLVERINE	Oxford Blue	EC
CERTAINEED/WOLVERINE	Pacific Blue	T8
CERTAINEED/WOLVERINE	Pale Ivory	BD
CERTAINEED/WOLVERINE	Rustic Blend*	100
CERTAINEED/WOLVERINE	Sable Brown	BQ
CERTAINEED/WOLVERINE	Sandpiper	PD
CERTAINEED/WOLVERINE	Sandstone Beige	EM
CERTAINEED/WOLVERINE	Savannah Wicker	FP
CERTAINEED/WOLVERINE	Sea Breeze	RB
CERTAINEED/WOLVERINE	Seagrass	510
CERTAINEED/WOLVERINE	Silver Ash	BM
CERTAINEED/WOLVERINE	Snow	EG
CERTAINEED/WOLVERINE	Spruce	SS
CERTAINEED/WOLVERINE	Sterling Gray	A4
CERTAINEED/WOLVERINE	Suede	SQ
CERTAINEED/WOLVERINE	Summer Wheat	49
CERTAINEED/WOLVERINE	Terra Cotta	GQ
CERTAINEED/WOLVERINE	Timber Blend*	JL
CERTAINEED/WOLVERINE	Warm Sand	EX
CERTAINEED/WOLVERINE	Weathered Blend*	JH
CERTAINEED/WOLVERINE	Woodland Mist	S1
CERTAINEED FIBER CEMENT	Antique White	EE
CERTAINEED FIBER CEMENT	Autumn Red	GI
CERTAINEED FIBER CEMENT	Butter	63
CERTAINEED FIBER CEMENT	Coastal Blue	A4
CERTAINEED FIBER CEMENT	Desert Gold	GP
CERTAINEED FIBER CEMENT	Heather	JK
CERTAINEED FIBER CEMENT	Heritage Clay	JA

* Recommended solid color match for a variegated color.

Brand	Color Name	Color
CERTAINEED FIBER CEMENT	Linen	BI
CERTAINEED FIBER CEMENT	Merino Tan	39
CERTAINEED FIBER CEMENT	Nantucket Gray	100
CERTAINEED FIBER CEMENT	Newport Taupe	68
CERTAINEED FIBER CEMENT	Olive	IA
CERTAINEED FIBER CEMENT	Pewter	290
CERTAINEED FIBER CEMENT	Silverplate	ND
CERTAINEED FIBER CEMENT	White	04
CERTAINEED FIBER CEMENT	Wicker	FJ
EXTERIOR PORTFOLIO (CRANE)	Aspen White	04
EXTERIOR PORTFOLIO (CRANE)	Bone	BI
EXTERIOR PORTFOLIO (CRANE)	Cabin	BS
EXTERIOR PORTFOLIO (CRANE)	Clay	52
EXTERIOR PORTFOLIO (CRANE)	Country Beige	FJ
EXTERIOR PORTFOLIO (CRANE)	Cypress	GP
EXTERIOR PORTFOLIO (CRANE)	Desert	IA
EXTERIOR PORTFOLIO (CRANE)	Driftwood	A4
EXTERIOR PORTFOLIO (CRANE)	Espresso	BQ
EXTERIOR PORTFOLIO (CRANE)	Evergreen	D2
EXTERIOR PORTFOLIO (CRANE)	Graphite	RE
EXTERIOR PORTFOLIO (CRANE)	Greystone	EW
EXTERIOR PORTFOLIO (CRANE)	Harbor Blue	GA
EXTERIOR PORTFOLIO (CRANE)	Honey Oak	254
EXTERIOR PORTFOLIO (CRANE)	Ivory	EV
EXTERIOR PORTFOLIO (CRANE)	Lighthouse Red	290
EXTERIOR PORTFOLIO (CRANE)	Midnight Surf	156 or RD
EXTERIOR PORTFOLIO (CRANE)	Mocha	22
EXTERIOR PORTFOLIO (CRANE)	Nutmeg	ID
EXTERIOR PORTFOLIO (CRANE)	Olive	IC
EXTERIOR PORTFOLIO (CRANE)	Pearl	31
EXTERIOR PORTFOLIO (CRANE)	Regatta	146 or LA
EXTERIOR PORTFOLIO (CRANE)	Rye	EY
EXTERIOR PORTFOLIO (CRANE)	Saddle	39

Brand	Color Name	Color
EXTERIOR PORTFOLIO (CRANE)	New Slate	156 or RD
EXTERIOR PORTFOLIO (CRANE)	Stratford Blue	GG
EXTERIOR PORTFOLIO (CRANE)	Wheat	63
FOUNDRY	Aged Chestnut*	BF
FOUNDRY	Almond	EV
FOUNDRY	Antique Cream*	EN
FOUNDRY	Biscuit	39
FOUNDRY	Blueberry	No Close Match
FOUNDRY	Butter Pecan*	PD
FOUNDRY	Classic Sand*	EN
FOUNDRY	Cocoa	E7
FOUNDRY	Coconut	EM
FOUNDRY	Cottonwood*	EN
FOUNDRY	Driftwood	E0
FOUNDRY	Eggshell	31
FOUNDRY	Harvest Wheat*	PC
FOUNDRY	Honey Brown*	JA
FOUNDRY	Juniper	JF
FOUNDRY	Keylime	RG
FOUNDRY	Lemonade	LW
FOUNDRY	Moonlight	02
FOUNDRY	Moss	510
FOUNDRY	Oatmeal	FP
FOUNDRY	Oceanside	No Close Match
FOUNDRY	Papaya	RP
FOUNDRY	Putty	53
FOUNDRY	Russet	GJ
FOUNDRY	Rustic Brown	E9
FOUNDRY	Sahara	22
FOUNDRY	Sandalwood*	PC
FOUNDRY	Seashell	C3
FOUNDRY	Seaside Grey*	EI
FOUNDRY	Shadow	52

* Recommended solid color match for a variegated color.

Brand	Color Name	Color
FOUNDRY	Shale	BL
FOUNDRY	Slate	36
FOUNDRY	Snow	PW
FOUNDRY	Toasted Almond*	EN
FOUNDRY	Toffee	PC
FOUNDRY	Vanilla Bean*	EN
FOUNDRY	Vintage Green*	BN
FOUNDRY	Vintage Taupe*	E4
GENTEK/REVERE	Almond	53
GENTEK/REVERE	Antique Ivory	39
GENTEK/REVERE	Brownstone	JA
GENTEK/REVERE	Canyon Clay	EY
GENTEK/REVERE	Classic Brown	JH
GENTEK/REVERE	Dark Drift	100
GENTEK/REVERE	Dover Gray	X4
GENTEK/REVERE	Harvest Wheat	GB
GENTEK/REVERE	Linen	44
GENTEK/REVERE	Maize	30
GENTEK/REVERE	Midnight Surf	156 or RD
GENTEK/REVERE	Mist Blue	46
GENTEK/REVERE	Moonlit Moss	GM
GENTEK/REVERE	Norwood	52
GENTEK/REVERE	Pearl	02
GENTEK/REVERE	Pebble	PC
GENTEK/REVERE	Saddle Brown	RF
GENTEK/REVERE	Sage	BZ
GENTEK/REVERE	Sandalwood	EX
GENTEK/REVERE	Sandstone	31
GENTEK/REVERE	Sandstone	EM
GENTEK/REVERE	Snow White	PW
GENTEK/REVERE	Venetian Red	290
GENTEK/REVERE	Wicker	A7
GENTEK/REVERE	Windswept Smoke	RE

Brand	Color Name	Color
GEORGIA-PACIFIC	Almond	53
GEORGIA-PACIFIC	Amber	254
GEORGIA-PACIFIC	Bayou	145
GEORGIA-PACIFIC	Beige	EX
GEORGIA-PACIFIC	Blue	BK
GEORGIA-PACIFIC	Briarwood	100
GEORGIA-PACIFIC	Clay	PC
GEORGIA-PACIFIC	Coastal Blue*	090
GEORGIA-PACIFIC	Cream	30
GEORGIA-PACIFIC	Flint	ED
GEORGIA-PACIFIC	Gray	02
GEORGIA-PACIFIC	Hampton Red	290
GEORGIA-PACIFIC	Hazelnut	260
GEORGIA-PACIFIC	Hearthstone Brown*	BQ
GEORGIA-PACIFIC	Mist	BI
GEORGIA-PACIFIC	Musket Brown	N5
GEORGIA-PACIFIC	Northern Oak*	PC
GEORGIA-PACIFIC	Olive	511
GEORGIA-PACIFIC	Palm	IC
GEORGIA-PACIFIC	Pearl	PP
GEORGIA-PACIFIC	Pewter	090
GEORGIA-PACIFIC	Redwood*	ID
GEORGIA-PACIFIC	Sagebrook	170
GEORGIA-PACIFIC	Shaded Cedar*	100
GEORGIA-PACIFIC	Shaded Gray*	ED
GEORGIA-PACIFIC	Shadow	144
GEORGIA-PACIFIC	Tan	A7
GEORGIA-PACIFIC	Teak	IF
GEORGIA-PACIFIC	Thistle	510
GEORGIA-PACIFIC	Wedgewood	390
GEORGIA-PACIFIC	White	PW
HEARTLAND	Almond	FL
HEARTLAND	Antique White	C3

* Recommended solid color match for a variegated color.

Brand	Color Name	Color
HEARTLAND	Aspen	170
HEARTLAND	Birchwood	EM
HEARTLAND	Blue	BK
HEARTLAND	Camel	GK
HEARTLAND	Canyon	100
HEARTLAND	Clay	52
HEARTLAND	Cream	30
HEARTLAND	Granite	EW
HEARTLAND	Gray	A4
HEARTLAND	Linen	HL
HEARTLAND	Mist	22
HEARTLAND	Mountain Berry	GJ
HEARTLAND	New Chateau	ES
HEARTLAND	New Mocha	E3
HEARTLAND	Olive	170
HEARTLAND	Pewter	36
HEARTLAND	Prairie	22
HEARTLAND	Sand	22
HEARTLAND	Sandalwood	FP
HEARTLAND	Sienna	18
HEARTLAND	Stone	JK
HEARTLAND	White	PW
JAMES HARDIE	Aged Pewter	BH
JAMES HARDIE	Arctic White	04
JAMES HARDIE	Autumn Tan	EN
JAMES HARDIE	Boothbay Blue	390
JAMES HARDIE	Chestnut Brown	RF
JAMES HARDIE	Cobble Stone	C3
JAMES HARDIE	Countrylane Red	GJ
JAMES HARDIE	Deep Ocean	LA
JAMES HARDIE	Evening Blue	156 or RD
JAMES HARDIE	Gray Slate	GI
JAMES HARDIE	Harris Cream	QU

Brand	Color Name	Color
JAMES HARDIE	Heathered Moss	JE
JAMES HARDIE	Iron Gray	QV
JAMES HARDIE	Khaki Brown	JL
JAMES HARDIE	Light Mist	X4
JAMES HARDIE	Monterey Taupe	BT
JAMES HARDIE	Mountain Sage	SS
JAMES HARDIE	Navajo Beige	53
JAMES HARDIE	Night Gray	BU
JAMES HARDIE	Parkside Pine	QW
JAMES HARDIE	Pearl Gray	36
JAMES HARDIE	Rich Espresso	RE
JAMES HARDIE	Sail Cloth	EV
JAMES HARDIE	Sandstone Beige	BF
JAMES HARDIE	Soft Green	18
JAMES HARDIE	Timber Bark	E4
JAMES HARDIE	Tuscan Gold	IA
JAMES HARDIE	Woodland Cream	10
JAMES HARDIE	Woodstock Brown	DD
KAYCAN	Azure Blue	BK
KAYCAN	Bisque	22
KAYCAN	Clay	EY
KAYCAN	Flagstone	FN
KAYCAN	Ivory	30
KAYCAN	Khaki	JA
KAYCAN	Linen White	C3
KAYCAN	Mocha	EX
KAYCAN	Pebblestone	22
KAYCAN	Prestige Beige	E0
KAYCAN	Quartz	BM
KAYCAN	Sage	510
KAYCAN	Sandalwood	53
KAYCAN	Slate Gray	36
KAYCAN	Terra Verde	BT

Brand	Color Name	Color
KAYCAN	White	04
KP BUILDING PRODUCTS	Almond	ET
KP BUILDING PRODUCTS	Antique Ivory	30
KP BUILDING PRODUCTS	Barn Red	GJ
KP BUILDING PRODUCTS	Blue Mist	EP
KP BUILDING PRODUCTS	Camel	GK
KP BUILDING PRODUCTS	Canvas	A7
KP BUILDING PRODUCTS	Cherry	S7
KP BUILDING PRODUCTS	Classic Linen	44
KP BUILDING PRODUCTS	Clay	EY
KP BUILDING PRODUCTS	Cobblestone	FP
KP BUILDING PRODUCTS	Cream	31
KP BUILDING PRODUCTS	Cypress	52
KP BUILDING PRODUCTS	Dusk	J9
KP BUILDING PRODUCTS	Forest	GM
KP BUILDING PRODUCTS	French Vanilla	30
KP BUILDING PRODUCTS	Graphite	EW
KP BUILDING PRODUCTS	Gray	FM
KP BUILDING PRODUCTS	Heritage Gray	02
KP BUILDING PRODUCTS	Khaki	JA
KP BUILDING PRODUCTS	Mahogany	148 or G0
KP BUILDING PRODUCTS	Meadow	S1
KP BUILDING PRODUCTS	Natural Oak	BM
KP BUILDING PRODUCTS	Ocean	T8
KP BUILDING PRODUCTS	Pine	22
KP BUILDING PRODUCTS	Prairie Wheat*	30
KP BUILDING PRODUCTS	Putty	53
KP BUILDING PRODUCTS	River Rock	17
KP BUILDING PRODUCTS	Sage	GP
KP BUILDING PRODUCTS	Sand	EX
KP BUILDING PRODUCTS	Sandstone	22
KP BUILDING PRODUCTS	Slate	FN
KP BUILDING PRODUCTS	Smoke	EI

Brand	Color Name	Color
KP BUILDING PRODUCTS	Spice	GQ
KP BUILDING PRODUCTS	Suede	100
KP BUILDING PRODUCTS	Tan	39
KP BUILDING PRODUCTS	Vermont Maple	39
KP BUILDING PRODUCTS	Weathered Wood*	BM
MASTIC	White	04
MASTIC	Almond	53
MASTIC	American Walnut*/Walnut*	E9
MASTIC	Aspen Grey*	EX
MASTIC	Autumn Harvest	251
MASTIC	Brandy Wood	147
MASTIC	Cameo	31
MASTIC	Cape Cod Grey*/Cape Grey*	36
MASTIC	Charcoal Grey	80
MASTIC	Classic Cream	30
MASTIC	Colonial Yellow	10
MASTIC	Corn Silk	210
MASTIC	Dark Bronze	JS
MASTIC	Deep Granite	090
MASTIC	Desert Sand	22
MASTIC	English Wedgewood	390
MASTIC	Everest	17
MASTIC	Glacier Blue*	E6
MASTIC	Harbor Gray	35
MASTIC	Lakeshore Fern	IC
MASTIC	Linen	44
MASTIC	Mahogany	148
MASTIC	Misty Shadow	144
MASTIC	Montana Suede	IF
MASTIC	Musket Brown	N5
MASTIC	Natural Cedar*/Cedar*	100
MASTIC	Natural Slate	156
MASTIC	Newport Bay	146

* Recommended solid color match for a variegated color.

Brand	Color Name	Color
MASTIC	Pebblestone Clay	52
MASTIC	Portsmouth Blue	IB
MASTIC	Quiet Willow	170
MASTIC	Red Brick	149
MASTIC	Red Cedar*	ID
MASTIC	Rugged Canyon	100
MASTIC	Russet Red	290
MASTIC	Sage	18
MASTIC	Sandtone	39
MASTIC	Scottish Thistle	510
MASTIC	Silver Grey	02
MASTIC	Terra Cotta	ID
MASTIC	Timberstone*/Timber*	E7
MASTIC	Tuscan Olive	511
MASTIC	Victorian Grey	36
MASTIC	Vineyard Grove	252
MASTIC	White	04
MASTIC	Wicker	A7
MASTIC	Woodland Green*	E4
MITTEN	Amber	QK
MITTEN	Annapolis Blue	T8
MITTEN	Ash	BM
MITTEN	Aviator Green	QL
MITTEN	Bone	HL
MITTEN	Brownstone	PC
MITTEN	Burnt Orange	QM
MITTEN	Caribou Brown	RF
MITTEN	Chestnut Brown	G0
MITTEN	Clay	EY
MITTEN	Coffee Bean	BS
MITTEN	Cypress	JE
MITTEN	Danish Gold	QI
MITTEN	Eggplant	QN

Brand	Color Name	Color
MITTEN	Flagstone	X4
MITTEN	Frost	04M
MITTEN	Grenadier Green	QP
MITTEN	Gunmetal Grey	QY
MITTEN	Hearthstone	A7
MITTEN	Ivory	30
MITTEN	Khaki Brown	DDM
MITTEN	Lighthouse Red	QH
MITTEN	Lite Maple	ET
MITTEN	Muskoka Green	ICM
MITTEN	Rainforest	SS
MITTEN	Regatta Blue	QX
MITTEN	Richmond Red	GJ
MITTEN	Rockaway Grey	144
MITTEN	Saffron	QR
MITTEN	Sage	510
MITTEN	Sandalwood	JP
MITTEN	Sandcastle	22
MITTEN	Sapphire Blue	QJ
MITTEN	Satin Grey	A4
MITTEN	Spring Moss	QT
MITTEN	Stratus	EA
MITTEN	Timber Bark	EAM
NAILITE	Antique Gray	DD
NAILITE	Ashwood	EJ
NAILITE	Barn Red	290
NAILITE	Canary Yellow	LW
NAILITE	Classic White	04
NAILITE	Denim Blue	LY
NAILITE	Desert Clay	63
NAILITE	Desert Sand	FP
NAILITE	Eggshell	53
NAILITE	Forest Green	LX

Brand	Color Name	Color
NAILITE	Harvest Cedar	BS
NAILITE	Khaki/Sunset Cedar	GB
NAILITE	Pale Yellow	10
NAPCO	American Hazelnut	260
NAPCO	Blue Bayou	145
NAPCO	Canyon Beige	EX
NAPCO	Cape Blue	FK
NAPCO	Catalina Sandtone	39
NAPCO	Cordoba Olive	511
NAPCO	Country Cream	EZ
NAPCO	Desert Cactus	510
NAPCO	Evening Shadow	144
NAPCO	Fieldstone Flint	ED
NAPCO	Heritage Linen	HL
NAPCO	Herringbone Mist	66
NAPCO	Island Palm	IC
NAPCO	Lakeshore Gray	02
NAPCO	Liberty White	PW
NAPCO	Monterey Almond	53
NAPCO	Mountain Briarwood	100
NAPCO	Musket Brown	N5
NAPCO	Nantucket Pewter	090
NAPCO	Olde Town Wedgewood	390
NAPCO	Plantation Teak	IF
NAPCO	Rich Mocha	22
NAPCO	Sedona Red	290
NAPCO	Shaded Cedar*	100
NAPCO	Shaded Gray*	ED
NAPCO	Southwest Sagebrook	170
NAPCO	Stone Clay	PC
NAPCO	Sunset Amber	254
NAPCO	Wheatfield Tan	A7
NORANDEX	Almond	53

Brand	Color Name	Color
NORANDEX	Almond	EE
NORANDEX	Beige	31
NORANDEX	Cactus	BZ
NORANDEX	Cape Blue	FK
NORANDEX	Champagne	BI
NORANDEX	Cobblestone	PC
NORANDEX	Colonial Grey	36
NORANDEX	Cream	EV
NORANDEX	Cream	30
NORANDEX	Dune	FL
NORANDEX	Evergreen	JF
NORANDEX	Fire Brick	290
NORANDEX	Granite	GI
NORANDEX	Hazel	JC
NORANDEX	Ivy	J6
NORANDEX	Linen	HL
NORANDEX	Pewter Grey	ED
NORANDEX	Russet	100
NORANDEX	Saddle	GB
NORANDEX	Sand	FP
NORANDEX	Sandstone	BF
NORANDEX	Sierra	52
NORANDEX	Silver	02
NORANDEX	Steel Blue	No Close Match
NORANDEX	Tan	53
NORANDEX	Tumbleweed	63
NORANDEX	Wedgewood	ND
NORANDEX	Wheat	EN
NORANDEX	White	PW
RMC	Adobe Clay	52
RMC	Autumn Taupe	BM
RMC	Canyon Brown	IF
RMC	Charcoal Grey	EA

Brand	Color Name	Color
RMC	Classic Sand	EE
RMC	Concord Green	RG
RMC	Countryside Green	D2
RMC	Dove Gray	02
RMC	Frost White	PW
RMC	Hampton Blue	T8
RMC	Harbor Stone	A4
RMC	Harvest Brown*	E9
RMC	Heritage Red	GJ
RMC	Linen	44
RMC	Providence Yellow	10
RMC	Soft Heather	BE
RMC	Summer Wheat	49
RMC	Sunny Maize	30
RMC	Terra Clay	BL
RMC	Timber Wolfe*	ED
RMC	Victorian Slate	46
RMC	Vintage Sage	BZ
RMC	Warm Sandalwood	22
RMC	Whispering Pine*	GM
RMC	White Birch	04
RMC	Wicker Beige	BF
ROYAL	Beige	30
ROYAL	Blue	146 or LA
ROYAL	Blue Grey	GV
ROYAL	Blue Spruce*	No Close Match
ROYAL	Champagne	49
ROYAL	Charcoal Gray	BU
ROYAL	Chesapeake Green	GG
ROYAL	Clay	EY
ROYAL	Cocoa	BS
ROYAL	Country Green	D2
ROYAL	Cypress	JE

Brand	Color Name	Color
ROYAL	Driftwood	C3
ROYAL	Espresso	RE
ROYAL	Flagstone	510
ROYAL	Gray	X4
ROYAL	Granite	RE
ROYAL	Green	RG
ROYAL	Hampton Blue	390
ROYAL	Harvard Slate	EA
ROYAL	Heather	E0
ROYAL	Highland Cedar*	E9
ROYAL	Honey Oak	IA
ROYAL	Ironstone	RE
ROYAL	Linen	HL
ROYAL	Meadow Green*	BH
ROYAL	Midnight Surf	T8
ROYAL	Mountain Blue	BK
ROYAL	Natural Cedar	RF
ROYAL	Pebble Clay	52
ROYAL	Red Cedar*	GJ
ROYAL	Redwood	290
ROYAL	Rustic Red	290
ROYAL	Sage	EI
ROYAL	Sand	22
ROYAL	Shamrock	GM
ROYAL	Soft Maple	ET
ROYAL	Sterling	BI
ROYAL	Sunflower	M0
ROYAL	Victorian Gray	36
ROYAL	Vintage Cream	EV
ROYAL	Walnut	100
ROYAL	Wedgewood	156 or RD
ROYAL	White	PW
ROYAL	Wicker	A7

* Recommended solid color match for a variegated color.

Brand	Color Name	Color
ROYAL	Yellow	10
ROYAL	Royal Wedgewood	WGD
ROYAL	Royal Cocoa	COC
ROYAL	Royal Bark	BRK
ROYAL	Royal Ironstone	IST
VARIFORM	Adirondack Oak*	FQ
VARIFORM	Amber	254
VARIFORM	Appalachian Chestnut *	BQ
VARIFORM	Autumn Beige	EX
VARIFORM	Bayou	145
VARIFORM	Briarwood	100
VARIFORM	Cabin Cedar*	100
VARIFORM	Catskill Maple*	100
VARIFORM	Classic Cream	30
VARIFORM	Coastal Blue	090
VARIFORM	Cottage Gray*	ED
VARIFORM	Delray Sand	63
VARIFORM	Dover White	PW
VARIFORM	Flint	ED
VARIFORM	Georgian Gray	02
VARIFORM	Hazelnut	260
VARIFORM	Hearthstone Brown	BQ
VARIFORM	Irish Thistle	510
VARIFORM	Ironwood*	090
VARIFORM	Island Pearl	PP
VARIFORM	Mediterranean Palm	IC
VARIFORM	Mesabi Cherry*	S7
VARIFORM	Musket Brown	N5
VARIFORM	Natural Almond	53
VARIFORM	Northern Oak	PC
VARIFORM	Pewter	090
VARIFORM	Redwood	ID
VARIFORM	Sagebrook	170

Brand	Color Name	Color
VARIFORM	Sandtone	39
VARIFORM	Sandy Tan	A7
VARIFORM	Savannah Blue	BK
VARIFORM	Sedona Red	290
VARIFORM	Sierra Mesquite*	170
VARIFORM	Silver Mist	BI
VARIFORM	Spanish Olive	511
VARIFORM	Stone Mountain Clay	PC
VARIFORM	Sycamore*	090
VARIFORM	Teak	IF
VARIFORM	Twilight Shadow	144
VARIFORM	Wedgewood	390
VYTEK	Antique Ivory	30
VYTEK	Autumn Ash	BM
VYTEK	Autumn Leaf	E4
VYTEK	California Coast	10
VYTEK	Castle Ridge	DD
VYTEK	Clay	PC
VYTEK	Clipper Gray	02
VYTEK	Country Almond	49
VYTEK	Dark Brown	N5
VYTEK	Desert	53
VYTEK	Driftwood	BI
VYTEK	Estate Gray	36
VYTEK	Forest	GM
VYTEK	Harbor	156 or RD
VYTEK	Horizon Blue	EP
VYTEK	Irish Linen	31
VYTEK	Lakeshore Blue	390
VYTEK	Redwood	GJ
VYTEK	Sage Green	BN
VYTEK	Sand	PC
VYTEK	Shoreline	100

Brand	Color Name	Color
VYTEK	Sierra Brown	FJ
VYTEK	Smokestone	RE
VYTEK	Spring Meadow	GP
VYTEK	Storm	EA
VYTEK	Tundra Moss	510
VYTEK	Twilight Gray	FN
VYTEK	White	PW

24" Smooth Trim Coil (Coated two sides)

Product Code: **ASC24**

Description	Package
Finish: Smooth Acrylic	1 Roll/Ctn.
Nominal .019" Thick	24.6 Lbs./Ctn.
Length: 50'	



Color Availability

Front	Back	Front	Back
White	White	Musket Brown	White
Almond	White	Nantucket Gray	White
Autumn Tan	White	Olive	White
Beige	White	Pewter	White
Black	White	Royal Brown	White
Black	Musket Brown	Russet Red	White
Black	Royal Brown	Sand	White
Canyon	White	Shaded Cedar	White
Chestnut	White	Shaded Gray	White
Cocoa Bean	White	Shadow	White
Copper Penny	White	Slate Blue	White
Evergreen	White	Spruce Blue	White
French Silk	White	Stone Gray	White
Granite	White	Terra Bronze	White
Hickory	White	Thistle	White
Ivory	White	Weathered Ash	White
Juniper	White	Wedgewood	White
Khaki	White	Wicker	White
Mist	White	Willow	White
Montana Suede	White		



THIS PRODUCT HAS BEEN GREEN APPROVED BY THE NAHB RESEARCH CENTER. This means you can be assured that this product complies with specific green practice criteria in the National Green Building Standard. Visit www.GreenApprovedProducts.com for more details.

24" Textured Trim Coil (Coated one side)

Product Code: **ATC24**

Description	Package
Finish: Striated PVC	1 Roll/Ctn.
Nominal .019" Thick	26.2 Lbs./Ctn.
Length: 50'	

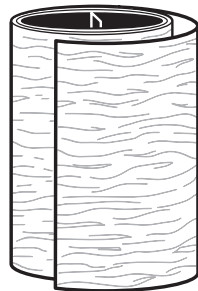

Color Availability

White, Almond, Autumn Tan, Beige, Canyon, Evergreen, French Silk, Granite, Ivory, Khaki, Mist, Montana Suede, Musket Brown, Nantucket Gray, Olive, Pewter, Russet Red, Royal Brown, Sand, Shaded Cedar, Shaded Gray, Shadow, Slate Blue, Stone Gray, Terra Bronze, Thistle, Weathered Ash, Wedgewood, Wicker, Willow

Note: Backside coated with neutral color or washcoat.



THIS PRODUCT HAS BEEN GREEN APPROVED BY THE NAHB RESEARCH CENTER. This means you can be assured that this product complies with specific green practice criteria in the National Green Building Standard. Visit www.GreenApprovedProducts.com for more details.

TRIM COIL

14" Smooth Trim Coil (Coated two sides)

Product Code: **ASC14**

Description	Package
Finish: Smooth Acrylic	1 Roll/Ctn.
Nominal .019" Thick	14.4 Lbs./Ctn.
Length: 50'	

Color Availability	
Front	Back
White	White
Black	Musket Brown
Black	Royal Brown

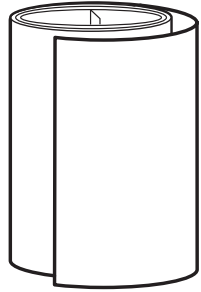

THIS PRODUCT HAS BEEN GREEN APPROVED BY THE NAHB RESEARCH CENTER. This means you can be assured that this product complies with specific green practice criteria in the National Green Building Standards. Visit www.GreenApprovedProducts.com for more details.

24" Economy Smooth Trim Coil

Product Code: **EC24**

Description	Package
Finish: Smooth Acrylic	1 Roll/Ctn.
Nominal .018" Thick	23.6 Lbs./Ctn.
Length: 50'	

Color Availability	
Front	Back
White	White
Black	White
Black	Musket Brown
Black	Royal Brown
Musket Brown	White
Window Almond (Maple)	Window White (Snow)

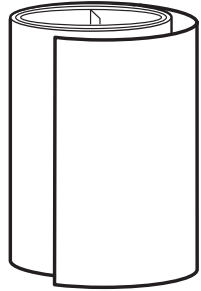

THIS PRODUCT HAS BEEN GREEN APPROVED BY THE NAHB RESEARCH CENTER. This means you can be assured that this product complies with specific green practice criteria in the National Green Building Standards. Visit www.GreenApprovedProducts.com for more details.

24" Economy Textured Trim Coil (Coated one side)

Product Code: **EC24T**

Description	Package
Finish: Striated PVC	1 Roll/Ctn.
Nominal .018" Thick	24.0 Lbs./Ctn.
Length: 50'	

Color Availability	
White	

Note: Backside coated with neutral color or washcoat.



THIS PRODUCT HAS BEEN GREEN APPROVED BY THE NAHB RESEARCH CENTER. This means you can be assured that this product complies with specific green practice criteria in the National Green Building Standard. Visit www.GreenApprovedProducts.com for more details.

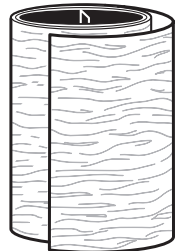

Brand	Color Name	Code 366+ Acrylic	Code 366+ PVC
ALSIDE	Champagne	35404	35434
ALSIDE	Colonial Ivory	48140	48160
ALSIDE	Glacier White	27243	28321
ALSIDE	Maple	41532	41502
ALSIDE	Monterey Sand	42632	28632
ALSIDE	Natural Linen	27113	28313
ALSIDE	Platinum Gray	29286	28331
ALSIDE	Tuscon Clay	28386	29386
ALSIDE	Vintage Wicker	45856	35435
CERTAINEED	Arbor Blend*	27292	28292
CERTAINEED	Arctic Blend*	27293	N/A
CERTAINEED	Autumn Red	27347	N/A
CERTAINEED	Autumn Yellow	29301	28302
CERTAINEED	Buckskin	28204	29232
CERTAINEED	Canyon Blend*	27294	N/A
CERTAINEED	Charcoal Gray	29370	28365
CERTAINEED	Colonial White	27243	28321
CERTAINEED	Cypress	29222	47112
CERTAINEED	Desert Tan	41532	41502
CERTAINEED	Flagstone	27295	28284
CERTAINEED	Forest	27346	N/A
CERTAINEED	Frontier Blend*	27296	N/A
CERTAINEED	Glacier Blend*	45852	N/A
CERTAINEED	Granite Gray	29202	28115
CERTAINEED	Green Tea	27344	N/A
CERTAINEED	Hearthstone	29368	28363
CERTAINEED	Heritage Cream	29787	28357
CERTAINEED	Herringbone	45863	36751
CERTAINEED	Ivy Green	29203	47102
CERTAINEED	Light Maple	48140	48160
CERTAINEED	Linen	29789	28190
CERTAINEED	Meadow Blend*	27276	28276
CERTAINEED	Natural Clay	35304	35441
CERTAINEED	Oxford Blue	45854	47105
CERTAINEED	Pacific Blue	29205	47106
CERTAINEED	Sable Brown	29206	47111
CERTAINEED	Sandpiper	27290	N/A

TRIM COIL

Brand	Color Name	Code 366+ Acrylic	Code 366+ PVC
CERTAINEED	Sandstone Beige	48132	48152
CERTAINEED	Savannah Wicker	45856	35435
CERTAINEED	Seagrass	27267	28330
CERTAINEED	Silver Ash	48131	48151
CERTAINEED	Snow	27243	47103
CERTAINEED	Spruce	27345	N/A
CERTAINEED	Sterling Gray	45852	47107
CERTAINEED	Suede	27289	N/A
CERTAINEED	Terra Cotta	27612	28612
CERTAINEED	Timber Blend*	35304	N/A
CERTAINEED	Warm Sand	45858	47108
CERTAINEED	Weathered Blend*	27275	28275
EXTERIOR PORTFOLIO (CRANE)	Aspen White	27243	28321
EXTERIOR PORTFOLIO (CRANE)	Bone	45863	36751
EXTERIOR PORTFOLIO (CRANE)	Cabin	28309	29306
EXTERIOR PORTFOLIO (CRANE)	Clay	42637	42607
EXTERIOR PORTFOLIO (CRANE)	Country Beige	42632	28632
EXTERIOR PORTFOLIO (CRANE)	Cypress	29272	42281
EXTERIOR PORTFOLIO (CRANE)	Desert	28241	29241
EXTERIOR PORTFOLIO (CRANE)	Driftwood	42634	42604
EXTERIOR PORTFOLIO (CRANE)	Espresso	27711	28711
EXTERIOR PORTFOLIO (CRANE)	Graphite	27248	28248
EXTERIOR PORTFOLIO (CRANE)	Greystone	27712	28712
EXTERIOR PORTFOLIO (CRANE)	Harbor Blue	42641	42611
EXTERIOR PORTFOLIO (CRANE)	Honey Oak	28204	29232
EXTERIOR PORTFOLIO (CRANE)	Ivory	42635	42605
EXTERIOR PORTFOLIO (CRANE)	Lighthouse Red	28311	29303
EXTERIOR PORTFOLIO (CRANE)	Mocha	27250	28250
EXTERIOR PORTFOLIO (CRANE)	Nutmeg	27612	28612
EXTERIOR PORTFOLIO (CRANE)	Olive	28249	29249
EXTERIOR PORTFOLIO (CRANE)	Pearl	42631	42601
EXTERIOR PORTFOLIO (CRANE)	Regatta	28310	29308
EXTERIOR PORTFOLIO (CRANE)	Rye	29220	42615
EXTERIOR PORTFOLIO (CRANE)	Saddle	28389	29389
EXTERIOR PORTFOLIO (CRANE)	Slate	27268	28268
EXTERIOR PORTFOLIO (CRANE)	Stratford Blue	27247	28247
EXTERIOR PORTFOLIO (CRANE)	Wheat	29279	42282

TRIM COIL

Brand	Color Name	Code 366+ Acrylic	Code 366+ PVC
GENERAL INDUSTRY	Antique Ivory	29224	N/A
GENERAL INDUSTRY	Black	27216	28216
GENERAL INDUSTRY	Black/Musket Brown	27278	N/A
GENERAL INDUSTRY	Black/Royal Brown	27376	N/A
GENERAL INDUSTRY	Black/Window White	27271	N/A
GENERAL INDUSTRY	Brandy	29378	N/A
GENERAL INDUSTRY	Carey Tan	29225	N/A
GENERAL INDUSTRY	Cocoa Bean	27299	N/A
GENERAL INDUSTRY	Copper Penny	27135	N/A
GENERAL INDUSTRY	Cranberry	29223	N/A
GENERAL INDUSTRY	Dark Bronze	28391	29391
GENERAL INDUSTRY	Dark Bronze/Window White	27277	N/A
GENERAL INDUSTRY	Evening Gray	29379	N/A
GENERAL INDUSTRY	Forest	29377	35377
GENERAL INDUSTRY	Grecian Green	27262	28337
GENERAL INDUSTRY	Harbour	N/A	28341
GENERAL INDUSTRY	Imperial Brown	29226	N/A
GENERAL INDUSTRY	London Brown	27381	28381
GENERAL INDUSTRY	Musket Brown	27260	29373
GENERAL INDUSTRY	Norwegian Wood	27151	35151
GENERAL INDUSTRY	Pearl Gray	29227	N/A
GENERAL INDUSTRY	Royal Brown	27259	28326
GENERAL INDUSTRY	Sandalwood	27269	N/A
GENERAL INDUSTRY	Scotch Pine	28312	N/A
GENERAL INDUSTRY	Terra Cotta	27612	28612
GENERAL INDUSTRY	Terratone	27251	28251
GENERAL INDUSTRY	Tuxedo Gray	29228	28228
GENERAL INDUSTRY	Wine	N/A	28342
GEORGIA-PACIFIC	Almond	27263	28332
GEORGIA-PACIFIC	Amber	27254	28254
GEORGIA-PACIFIC	Bayou	27145	28145
GEORGIA-PACIFIC	Beige	27265	28334
GEORGIA-PACIFIC	Blue	35401	35431
GEORGIA-PACIFIC	Briarwood	29368	28363
GEORGIA-PACIFIC	Clay	35304	35441
GEORGIA-PACIFIC	Coastal Blue*	29379	N/A
GEORGIA-PACIFIC	Cream	27266	28336

TRIM COIL

Brand	Color Name	Code 366+ Acrylic	Code 366+ PVC
GEORGIA-PACIFIC	Flint	44840	44810
GEORGIA-PACIFIC	Gray	27246	28331
GEORGIA-PACIFIC	Hampton Red	27391	28360
GEORGIA-PACIFIC	Hazelnut	29260	28260
GEORGIA-PACIFIC	Hearthstone Brown*	27275	28275
GEORGIA-PACIFIC	Mist	45863	36751
GEORGIA-PACIFIC	Musket Brown	27260	29373
GEORGIA-PACIFIC	Northern Oak*	35304	35441
GEORGIA-PACIFIC	Olive	29511	28511
GEORGIA-PACIFIC	Palm	28249	29249
GEORGIA-PACIFIC	Pearl	35404	35434
GEORGIA-PACIFIC	Pewter	29370	28365
GEORGIA-PACIFIC	Redwood*	27009	N/A
GEORGIA-PACIFIC	Sagebrook	29374	28366
GEORGIA-PACIFIC	Shaded Cedar*	29368	28363
GEORGIA-PACIFIC	Shaded Gray*	44840	44810
GEORGIA-PACIFIC	Shadow	27144	28144
GEORGIA-PACIFIC	Tan	45856	35435
GEORGIA-PACIFIC	Teak	27143	28143
GEORGIA-PACIFIC	Thistle	27267	28330
GEORGIA-PACIFIC	Wedgewood	29369	28364
GEORGIA-PACIFIC	White	27243	28321
HEARTLAND	Almond	27263	28332
HEARTLAND	Antique White	44831	44801
HEARTLAND	Aspen	29374	28366
HEARTLAND	Birchwood	48132	48152
HEARTLAND	Camel	27279	N/A
HEARTLAND	Canyon	29368	28363
HEARTLAND	Chateau	28389	29389
HEARTLAND	Clay	35304	44807
HEARTLAND	Cream	29787	28357
HEARTLAND	Granite	29370	28365
HEARTLAND	Gray	44833	28331
HEARTLAND	Linen	29165	28196
HEARTLAND	Mist	29789	28190
HEARTLAND	Mountain Berry	29201	48154
HEARTLAND	Mocha	27296	N/A

TRIM COIL

Brand	Color Name	Code 366+ Acrylic	Code 366+ PVC
HEARTLAND	Pewter	44840	44810
HEARTLAND	Prairie	27297	N/A
HEARTLAND	Premium Blue	27303	28285
HEARTLAND	Sage	29222	47112
HEARTLAND	Sand	27250	28250
HEARTLAND	Sandalwood	44836	44806
HEARTLAND	Sienna	29791	28791
HEARTLAND	Stone	29375	N/A
HEARTLAND	White	27243	28321
JAMES HARDIE	Aged Pewter	27643	N/A
JAMES HARDIE	Alpine Frost	28388	29388
JAMES HARDIE	Arctic White	27243	28321
JAMES HARDIE	Autumn Tan	27620	28620
JAMES HARDIE	Boothbay Blue	29369	28364
JAMES HARDIE	Chestnut Brown	27621	N/A
JAMES HARDIE	Cobble Stone	45863	36751
JAMES HARDIE	Countrylane Red	27622	N/A
JAMES HARDIE	Deep Ocean	27627	N/A
JAMES HARDIE	Evening Blue	27623	28623
JAMES HARDIE	Gray Slate	27628	N/A
JAMES HARDIE	Heathered Moss	27573	28573
JAMES HARDIE	Iron Gray	27624	N/A
JAMES HARDIE	Khaki Brown	27625	28625
JAMES HARDIE	Light Mist	27246	28331
JAMES HARDIE	Monterey Taupe	35304	35441
JAMES HARDIE	Mountain Sage	28249	29249
JAMES HARDIE	Navajo Beige	27263	28332
JAMES HARDIE	Night Gray	27629	N/A
JAMES HARDIE	Pearl Gray	28387	29387
JAMES HARDIE	Rich Espresso	27644	N/A
JAMES HARDIE	Sail Cloth	45851	47109
JAMES HARDIE	Sandstone Beige	27276	28276
JAMES HARDIE	Timber Bark	27626	28626
JAMES HARDIE	Traditional Red	29201	48154
JAMES HARDIE	Woodland Cream	29787	28357
JAMES HARDIE	Woodstock Brown	27581	28581
KP/ABTCO	Almond	29175	28178

TRIM COIL

Brand	Color Name	Code 366+ Acrylic	Code 366+ PVC
KP/ABTCO	Barn Red	28311	29303
KP/ABTCO	Camel	27210	28210
KP/ABTCO	Canvas	29220	42615
KP/ABTCO	Classic Linen	44831	44801
KP/ABTCO	Clay	35304	44807
KP/ABTCO	Dusk	27292	N/A
KP/ABTCO	Forest	27317	28317
KP/ABTCO	Graphite	29370	28365
KP/ABTCO	Heritage Gray	29737	28777
KP/ABTCO	Heron	27017	28017
KP/ABTCO	Khaki	29290	28180
KP/ABTCO	Mahogany	27148	28148
KP/ABTCO	Ocean	29205	47106
KP/ABTCO	Prairie Wheat*	29787	28357
KP/ABTCO	Putty	27263	28332
KP/ABTCO	Sage	29222	47112
KP/ABTCO	Sandstone	29211	28199
KP/ABTCO	Slate	44840	44810
KP/ABTCO	Smoke	29375	N/A
KP/ABTCO	Spice	27612	28612
KP/ABTCO	Suede	29368	28363
KP/ABTCO	Tan	28389	28191
KP/ABTCO	White	27243	28321
KP/ABTCO	Wicker	45856	35435
MASTIC	White	27243	28321
MASTIC	Almond	27263	28332
MASTIC	Autumn Harvest	35251	29251
MASTIC	Aspen Grey	27297*	N/A
MASTIC	Brandy Wood	27147	28147
MASTIC	Brick Red	27149	28149
MASTIC	Bronze	29392	N/A
MASTIC	Cameo	35404	35434
MASTIC	Charcoal Gray	27380	N/A
MASTIC	Classic Cream	27266	28336
MASTIC	Corn Silk	27210	28210
MASTIC	Dark Bronze	28391	29391
MASTIC	Deep Granite	29370	28365

Brand	Color Name	Code 366+ Acrylic	Code 366+ PVC
MASTIC	Desert Sand	27250	28250
MASTIC	English Wedgewood	29369	28364
MASTIC	Everest	27017	28017
MASTIC	Evergreen	29377	35377
MASTIC	Harbor Grey	29202	28115
MASTIC	Lakeshore Fern	28249	29249
MASTIC	Linen	28388	29388
MASTIC	Mahogany	27148	28148
MASTIC	Misty Shadow	27144	28144
MASTIC	Montana Suede	27143	28143
MASTIC	Musket Brown	27260	29373
MASTIC	Natural Slate	27156	28156
MASTIC	Newport Bay	27146	28146
MASTIC	Pebblestone Clay	28386	29386
MASTIC	Portsmouth Blue	27247	28247
MASTIC	Quiet Willow	29374	28366
MASTIC	Rugged Canyon	29368	28363
MASTIC	Russet Red	27391	28360
MASTIC	Sandtone	28389	29389
MASTIC	Scottish Thistle	27267	28330
MASTIC	Silver Grey	27246	28331
MASTIC	Terra Bronze	27208	28208
MASTIC	Terra Cotta	27612	28612
MASTIC	Tuscan Olive	29511	28511
MASTIC	Victorian Grey	28387	29387
MASTIC	Vineyard Grove	27252	28252
MASTIC	White	27243	28321
MASTIC	Wicker	45856	35435
MASTIC	Woodland Green*	27292	28292
MITTEN	Amber	52569	N/A
MITTEN	Annapolis Blue	29205	47106
MITTEN	Ash	52565	N/A
MITTEN	Aviator Green	52570	N/A
MITTEN	Bone	41539	41509
MITTEN	Brownstone	42637	42607
MITTEN	Burnt Orange	52568	N/A
MITTEN	Caribou Brown	52566	N/A

TRIM COIL

Brand	Color Name	Code 366+ Acrylic	Code 366+ PVC
MITTEN	Champagne	52586	N/A
MITTEN	Chestnut Brown	27148	28148
MITTEN	Clay	35304	35441
MITTEN	Coffee Bean	52572	N/A
MITTEN	Cypress	27573	28573
MITTEN	Danish Gold	52713	N/A
MITTEN	Dark Bronze	28391	29391
MITTEN	Eggplant	27574	N/A
MITTEN	Flagstone	27585	28585
MITTEN	Frost	27243	28321
MITTEN	Grenadier Green	28249	29249
MITTEN	Gunmetal Grey	28391	29391
MITTEN	Hearthstone	45856	35435
MITTEN	Iron Ore	52552	N/A
MITTEN	Ivory	27266	28336
MITTEN	Khaki Brown	29368	28363
MITTEN	Lighthouse Red	52714	N/A
MITTEN	Lite Maple	28389	29389
MITTEN	Muskoka Green	27575	N/A
MITTEN	Rain Forest	52577	N/A
MITTEN	Regatta Blue	52587	N/A
MITTEN	Richmond Red	27157	N/A
MITTEN	Rockaway Grey	27555	28555
MITTEN	Saffron	52578	N/A
MITTEN	Sage	52579	N/A
MITTEN	Sandcastle	27250	28250
MITTEN	Sandalwood	52557	N/A
MITTEN	Sapphire Blue	52716	N/A
MITTEN	Satin Grey	52580	N/A
MITTEN	Slate	52558	N/A
MITTEN	Spring Moss	27581	28581
MITTEN	Stratus	27583	28583
MITTEN	Timber Bark	27626	28626
MITTEN	Tumbleweed Tan	52562	N/A
MITTEN	White	27243	28321
NAPCO	American Hazelnut	29260	28260
NAPCO	Blue Bayou	27145	28145

Brand	Color Name	Code 366+ Acrylic	Code 366+ PVC
NAPCO	Canyon Beige	27265	28334
NAPCO	Cape Blue	43707	28333
NAPCO	Catalina Sandtone	28389	29389
NAPCO	Coastal Blue*	29379	N/A
NAPCO	Cordoba Olive	29511	28511
NAPCO	Country Cream	27266	28336
NAPCO	Desert Cactus	27267	28330
NAPCO	Evening Shadow	27144	28144
NAPCO	Fieldstone Flint	44840	44810
NAPCO	Hearthstone Brown*	27275	28275
NAPCO	Heritage Linen	27113	28313
NAPCO	Herringbone Mist	45863	36751
NAPCO	Island Palm	28249	29249
NAPCO	Lakeshore Gray	27246	28331
NAPCO	Liberty White	27243	28321
NAPCO	Monterey Almond	27263	28332
NAPCO	Mountain Briarwood	29368	28363
NAPCO	Musket Brown	27260	29373
NAPCO	Nantucket Pewter	29370	28365
NAPCO	Northern Oak*	35304	35441
NAPCO	Olde Town Wedgewood	29369	28364
NAPCO	Plantation Teak	27143	28143
NAPCO	Redwood*	27009	N/A
NAPCO	Rich Mocha	27250	28250
NAPCO	Sedona Red	27391	28360
NAPCO	Shaded Cedar*	29368	28363
NAPCO	Shaded Gray*	44840	44810
NAPCO	Southwest Sagebrook	29374	28366
NAPCO	Stone Clay	35304	35441
NAPCO	Sunset Amber	27254	28254
NAPCO	Wheatfield Tan	45856	35435
NORANDEX	Almond	27263	28332
NORANDEX	Beige	35404	35434
NORANDEX	Cactus	27N20	28N20
NORANDEX	Champagne	45863	36751
NORANDEX	Cobblestone	27N21	28N21
NORANDEX	Cream	27266	28336

TRIM COIL

Brand	Color Name	Code 366+ Acrylic	Code 366+ PVC
NORANDEX	Dune	48140	48160
NORANDEX	Evergreen	27N32	28N32
NORANDEX	Fern	27N27	28N27
NORANDEX	Firebrick	28311	29303
NORANDEX	Granite	27N23	28N23
NORANDEX	Graphite	27555	28555
NORANDEX	Hazel	27N30	28N30
NORANDEX	Ivy	27N31	28N31
NORANDEX	Khaki	27581	28581
NORANDEX	Linen	29165	28196
NORANDEX	Maverick Brown	29206	47111
NORANDEX	Mocha	29368	28363
NORANDEX	Olive	27N26	28N26
NORANDEX	Russet	27N29	28N29
NORANDEX	Saddle	27N33	28N33
NORANDEX	Sand	29211	28199
NORANDEX	Sandstone	45856	35435
NORANDEX	Seaport	27295	28284
NORANDEX	Sierra	42637	42607
NORANDEX	Silver	27246	28331
NORANDEX	Smoke	27712	28712
NORANDEX	Steel Blue	27N25	28N25
NORANDEX	Tan	41532	41502
NORANDEX	Tumbleweed	27625	28625
NORANDEX	Wedgewood	27N28	28N28
NORANDEX	Wheat	27N22	28N22
NORANDEX	White	27243	28321
NORANDEX	Yellow	29301	28302
ROYAL	Bark	27711	28711
ROYAL	Beige	29193	28357
ROYAL	Blue Grey	29738	28778
ROYAL	Brownstone	42637	42607
ROYAL	Charcoal Gray	27293	N/A
ROYAL	Clay	35304	44807
ROYAL	Cocoa	27259	28326
ROYAL	Cypress	29222	47112
ROYAL	Driftwood	45863	36751

Brand	Color Name	Code 366+ Acrylic	Code 366+ PVC
ROYAL	Flagstone	27267	28286
ROYAL	Granite	27208	28208
ROYAL	Gray	29192	28194
ROYAL	Harvard Slate	42633	28281
ROYAL	Heather	27286	28283
ROYAL	Heritage Blue	27287	N/A
ROYAL	Ironstone	29228	N/A
ROYAL	Linen	27113	28313
ROYAL	Midnight Surf	29205	47106
ROYAL	Natural Cedar	27284	N/A
ROYAL	Pebble Clay	28386	29386
ROYAL	Redwood	27391	28360
ROYAL	Sable	28204	29232
ROYAL	Sand	27250	28250
ROYAL	Shamrock	27317	28317
ROYAL	Soft Maple	48140	48160
ROYAL	Sterling	29286	28331
ROYAL	Victorian Gray	28387	N/A
ROYAL	Vintage Cream	29787	28357
ROYAL	Walnut	29368	28363
ROYAL	Wedgewood	27314	28314
ROYAL	White	27243	28321
ROYAL	Wicker	45856	35435
VARIFORM	Amber	27254	28254
VARIFORM	Autumn Beige	27265	28334
VARIFORM	Bayou	27145	28145
VARIFORM	Briarwood	29368	28363
VARIFORM	Cabin Cedar*	29368	28363
VARIFORM	Classic Cream	27266	28336
VARIFORM	Coastal Blue	29379	N/A
VARIFORM	Cottage Gray	44840	44810
VARIFORM	Delray Sand	29787	28357
VARIFORM	Dover White	27243	28321
VARIFORM	Flint	44840	44810
VARIFORM	Georgian Gray	27246	28331
VARIFORM	Hazelnut	29260	28260

TRIM COIL

Brand	Color Name	Code 366+ Acrylic	Code 366+ PVC
VARIFORM	Hearthstone Brown	27275	28275
VARIFORM	Irish Thistle	27267	28330
VARIFORM	Island Pearl	35404	35434
VARIFORM	Mediterranean Palm	28249	29249
VARIFORM	Musket Brown	27260	29373
VARIFORM	Natural Almond	27263	28332
VARIFORM	Northern Oak	35304	35441
VARIFORM	Pewter	29370	28365
VARIFORM	Redwood	27009	N/A
VARIFORM	Sagebrook	29374	28366
VARIFORM	Sandtone	28389	29389
VARIFORM	Sandy Tan	45856	35435
VARIFORM	Savannah Blue	35401	35431
VARIFORM	Sedona Red	27391	28360
VARIFORM	Silver Mist	45863	36751
VARIFORM	Spanish Olive	29511	28511
VARIFORM	Stone Mountain Clay	35304	35441
VARIFORM	Teak	27143	28143
VARIFORM	Twilight Shadow	27144	28144
VARIFORM	Wedgewood	29369	28364
VYTEC	Antique Ivory	27266	28336
VYTEC	Autumn Ash	48131	48151
VYTEC	Autumn Leaf	27581	N/A
VYTEC	Canyon Ridge	29368	28363
VYTEC	Castle Stone	27712	28712
VYTEC	Clipper Gray	27246	28331
VYTEC	Country Almond	40932	30098
VYTEC	Desert	28202	29230
VYTEC	Estate Gray	40933	40903
VYTEC	Forest	27575	N/A
VYTEC	Harbour	27268	28268
VYTEC	Horizon Blue	40934	40904
VYTEC	Irish Linen	41539	41509
VYTEC	Lakeshore Blue	27247	28247
VYTEC	Maplewood	48140	48160

TRIM COIL

Brand	Color Name	Code 366+ Acrylic	Code 366+ PVC
VYTEC	Redwood	28311	29303
VYTEC	Rustic Clay	42637	42607
VYTEC	Sage Green	27267	28330
VYTEC	Sandalwood	45858	47108
VYTEC	Shoreline	27143	28143
VYTEC	Sierra Brown	29221	40905
VYTEC	Smokestone	27248	28248
VYTEC	Southwestern Sand	35304	35441
VYTEC	Spring Meadow	27577	N/A
VYTEC	Storm	28201	29229
VYTEC	Terra Clay	35304	35441
VYTEC	Tundra Moss	52579	N/A
VYTEC	Twilight Gray	27246	28331
VYTEC	White	27243	28321

ALUMINUM SOFFIT

Double 6" .019" Soffit Solid

Product Code: AAS12219

Description

Finish: Smooth Acrylic
Nominal .019" Thick
Length: 12'
Exposure: 12"

Package

20 Pcs./Ctn.
240 Sq. Ft./Ctn.
76.1 Lbs./Ctn.

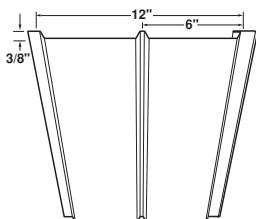

Color Availability

Musket Brown, White



THIS PRODUCT HAS BEEN GREEN APPROVED BY THE NAHB RESEARCH CENTER. This means you can be assured that this product complies with specific green practice criteria in the National Green Building Standard. Visit www.GreenApprovedProducts.com for more details.

Double 6" .019" Soffit Full-Lanced

Product Code: AFAS12219

Description

Finish: Smooth Acrylic
Nominal .019" Thick
Length: 12'
Exposure: 12"
10.6 Sq. In. N.F.A./Sq. Ft.

Package

20 Pcs./Ctn.
240 Sq. Ft./Ctn.
76.1 Lbs./Ctn.

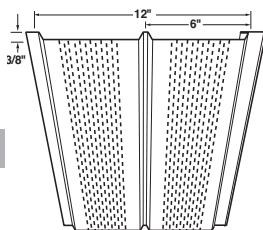

Color Availability

Musket Brown, White



THIS PRODUCT HAS BEEN GREEN APPROVED BY THE NAHB RESEARCH CENTER. This means you can be assured that this product complies with specific green practice criteria in the National Green Building Standard. Visit www.GreenApprovedProducts.com for more details.

Triple 4" .019" Soffit Solid

Product Code: **AAS12319**

Description

Finish: Smooth Acrylic
Nominal .019" Thick
Length: 12'
Exposure: 12"

Package

20 Pcs./Ctn.
240 Sq. Ft./Ctn.
77.7 Lbs./Ctn.



THIS PRODUCT HAS BEEN GREEN APPROVED BY THE NAHB RESEARCH CENTER. This means you can be assured that this product complies with specific green practice criteria in the National Green Building Standard. Visit www.GreenApprovedProducts.com for more details.

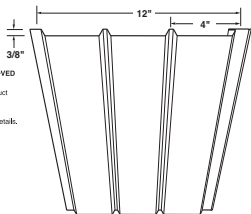

Triple 4" .019" Soffit Center-Lanced

Product Code: **ACAS12319**

Description

Finish: Smooth Acrylic
Nominal .019" Thick
Length: 12'
Exposure: 12"
4.4 Sq. In. N.F.A./Sq. Ft.

Package

20 Pcs./Ctn.
240 Sq. Ft./Ctn.
77.7 Lbs./Ctn.



THIS PRODUCT HAS BEEN GREEN APPROVED BY THE NAHB RESEARCH CENTER. This means you can be assured that this product complies with specific green practice criteria in the National Green Building Standard. Visit www.GreenApprovedProducts.com for more details.

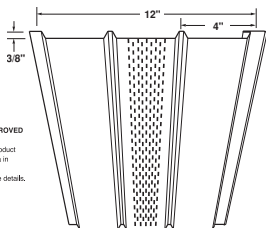

Triple 4" .019" Soffit Full-Lanced

Product Code: **AFAS12319**

Description

Finish: Smooth Acrylic
Nominal .019" Thick
Length: 12'
Exposure: 12"
13.2 Sq. In. N.F.A./Sq. Ft.

Package

20 Pcs./Ctn.
240 Sq. Ft./Ctn.
77.7 Lbs./Ctn.



THIS PRODUCT HAS BEEN GREEN APPROVED BY THE NAHB RESEARCH CENTER. This means you can be assured that this product complies with specific green practice criteria in the National Green Building Standard. Visit www.GreenApprovedProducts.com for more details.

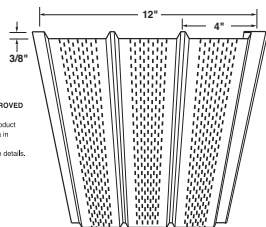

Color Availability

White, Almond, Autumn Tan, Beige, Black, Canyon, Dark Bronze, Evergreen, Ivory, Khaki, Montana Suede, Musket Brown, Nantucket Gray, Olive, Pewter, Royal Brown, Sand, Slate Blue, Stone Gray, Terra Bronze, Thistle, Wicker

ALUMINUM SOFFIT

Quad 4" .019" Soffit Solid

Product Code: AAS16419A

Description

Finish: Smooth Acrylic
Nominal .019" Thick
Length: 12'
Exposure: 16"

Package

14 Pcs./Ctn.
224 Sq. Ft./Ctn.
74.2 Lbs./Ctn.



THIS PRODUCT HAS BEEN GREEN APPROVED BY THE NAHB RESEARCH CENTER. This means you can be assured that this product complies with specific green practice criteria in the National Green Building Standard. Visit www.GreenApprovedProducts.com for more details.

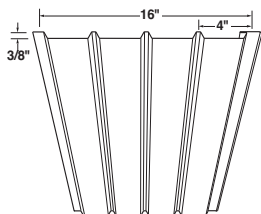

Quad 4" .019" Soffit Center-Lanced

Product Code: ACAS16419A

Description

Finish: Smooth Acrylic
Nominal .019" Thick
Length: 12'
Exposure: 12"
9.7 Sq. In. N.F.A./Sq. Ft.

Package

14 Pcs./Ctn.
224 Sq. Ft./Ctn.
74.2 Lbs./Ctn.



THIS PRODUCT HAS BEEN GREEN APPROVED BY THE NAHB RESEARCH CENTER. This means you can be assured that this product complies with specific green practice criteria in the National Green Building Standard. Visit www.GreenApprovedProducts.com for more details.

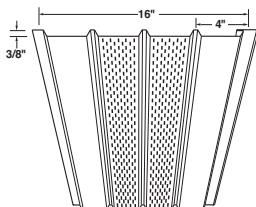

Color Availability

White, Almond, Autumn Tan, Beige, Black, Canyon, Dark Bronze, Evergreen, Ivory, Khaki, Montana Suede, Musket Brown, Nantucket Gray, Pewter, Royal Brown, Sand, Stone Gray, Terra Bronze, Wicker

Double 6" .016" Soffit Solid

Product Code: **AAS12216**

Description

Finish: Smooth Acrylic
Nominal .016" Thick
Length: 12'
Exposure: 12"

Package

20 Pcs./Ctn.
240 Sq. Ft./Ctn.
66.1 Lbs./Ctn.

Color Availability

White, Musket Brown



THIS PRODUCT HAS BEEN GREEN APPROVED BY THE NAHB RESEARCH CENTER.
This means you can be assured that this product complies with specific green practice criteria in the National Green Building Standard. Visit www.GreenApprovedProducts.com for more details.

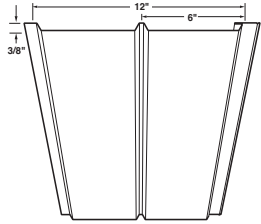

Double 6" .016" Soffit Full-Lanced

Product Code: **AFAS12216**

Description

Finish: Smooth Acrylic
Nominal .016" Thick
Length: 12'
Exposure: 12"
10.6 Sq. In. N.F.A./Sq. Ft.

Package

20 Pcs./Ctn.
240 Sq. Ft./Ctn.
66.1 Lbs./Ctn.

Color Availability

White, Musket Brown



THIS PRODUCT HAS BEEN GREEN APPROVED BY THE NAHB RESEARCH CENTER.
This means you can be assured that this product complies with specific green practice criteria in the National Green Building Standard. Visit www.GreenApprovedProducts.com for more details.

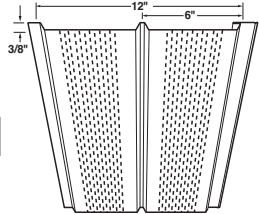

ALUMINUM SOFFIT

Triple 4" .016" Soffit Solid

Product Code: AAS12316

Description

Finish: Smooth Polymer
Nominal .016" Thick
Length: 12'
Exposure: 12"

Package

20 Pcs./Ctn.
240 Sq. Ft./Ctn.
67.4 Lbs./Ctn.



THIS PRODUCT HAS BEEN GREEN APPROVED BY THE NAHB RESEARCH CENTER. This means you can be assured that this product complies with specific green practice criteria in the National Green Building Standard. Visit www.GreenApprovedProducts.com for more details.

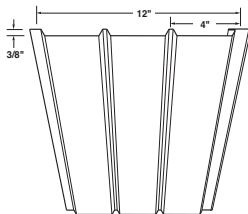

Triple 4" .016" Soffit Center-Lanced

Product Code: ACAS12316

Description

Finish: Smooth Acrylic
Nominal .016" Thick
Length: 12'
Exposure: 12"
4.4 Sq. In. N.F.A./Sq. Ft.

Package

20 Pcs./Ctn.
240 Sq. Ft./Ctn.
67.4 Lbs./Ctn.



THIS PRODUCT HAS BEEN GREEN APPROVED BY THE NAHB RESEARCH CENTER. This means you can be assured that this product complies with specific green practice criteria in the National Green Building Standard. Visit www.GreenApprovedProducts.com for more details.

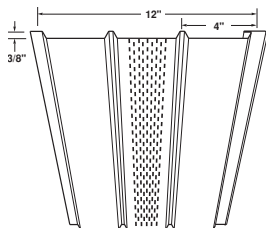

Triple 4" .016" Soffit Full-Lanced

Product Code: AFAS12316

Description

Finish: Smooth Acrylic
Nominal .016" Thick
Length: 12'
Exposure: 12"
13.2 Sq. In. N.F.A./Sq. Ft.

Package

20 Pcs./Ctn.
240 Sq. Ft./Ctn.
67.4 Lbs./Ctn.



THIS PRODUCT HAS BEEN GREEN APPROVED BY THE NAHB RESEARCH CENTER. This means you can be assured that this product complies with specific green practice criteria in the National Green Building Standard. Visit www.GreenApprovedProducts.com for more details.

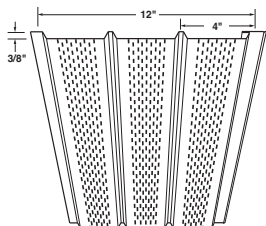

Color Availability

White, Almond, Autumn Tan, Beige, Black, Canyon, Dark Bronze, Evergreen, Ivory, Khaki, Montana Suede, Musket Brown, Nantucket Gray, Pewter, Royal Brown, Sand, Stone Gray, Terra Bronze, Wicker

ALUMINUM SOFFIT

Triple 4" .013 Soffit Solid

Product Code: **AAS12313**

Description

Finish: Smooth Acrylic
Nominal .013" Thick
Length: 12"
Exposure: 12"

Package

20 Pcs./Ctn.
240 Sq. Ft./Ctn.
52.7 Lbs.Ctn.

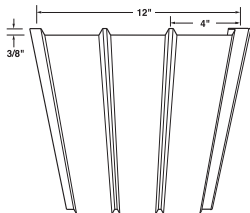

Color Availability

White



THIS PRODUCT HAS BEEN GREEN APPROVED BY THE NAHB RESEARCH CENTER. This means you can be assured that this product complies with specific green practice criteria in the National Green Building Standard. Visit www.GreenApprovedProducts.com for more details.

Triple 4" .013 Soffit Center-Lanced

Product Code: **ACAS12313**

Description

Finish: Smooth Acrylic
Nominal .013" Thick
Length: 12"
Exposure: 12"
4.4 Sq. In. N.F.A./Sq. Ft.

Package

20 Pcs./Ctn.
240 Sq. Ft./Ctn.
52.7 Lbs.Ctn.

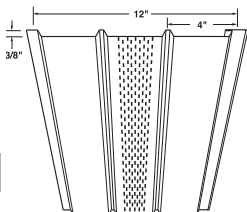

Color Availability

White



THIS PRODUCT HAS BEEN GREEN APPROVED BY THE NAHB RESEARCH CENTER. This means you can be assured that this product complies with specific green practice criteria in the National Green Building Standard. Visit www.GreenApprovedProducts.com for more details.

Triple 4" .013 Soffit Full-Lanced

Product Code: **AFAS12313**

Description

Finish: Smooth Acrylic
Nominal .013" Thick
Length: 12"
Exposure: 12"
13.2 Sq. In. N.F.A./Sq. Ft.

Package

20 Pcs./Ctn.
240 Sq. Ft./Ctn.
52.7 Lbs.Ctn.

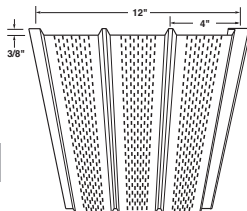

Color Availability

White



THIS PRODUCT HAS BEEN GREEN APPROVED BY THE NAHB RESEARCH CENTER. This means you can be assured that this product complies with specific green practice criteria in the National Green Building Standard. Visit www.GreenApprovedProducts.com for more details.

Soffit Touch Up Paint

Product Code: **WBTU**

Description

Package

6 Pcs./Ctn.
1 Oz./Bottle

Color Availability

White, Almond, Autumn Tan, Beige, Black, Canyon, Dark Bronze, Evergreen, Ivory, Khaki, Montana Suede, Montana Suede, Musket Brown, Nantucket Gray, Olive, Pewter, Royal Brown, Sand, Slate Blue, Stone Gray, Terra Bronze, Thistle, Wicker



ALUMINUM FASCIA

Woodgrain Embossed 4" Fascia Trim

Product Code: F1C4025

Description	Package
Finish: Smooth Acrylic	25 Pcs./Ctn.
Nominal .024" Thick	41 Lbs./Ctn.
Length: 12'	

Color Availability

White, Almond, Autumn Tan, Black, Dark Bronze, Evergreen, Ivory, Khaki, Montana Suede, Musket Brown, Royal Brown, Sand, Terra Bronze, Wicker



THIS PRODUCT HAS BEEN GREEN APPROVED BY THE NAHB RESEARCH CENTER. This means you can be assured that this product complies with specific green practice criteria in the National Green Building Standard. Visit www.GreenApprovedProducts.com for more details.

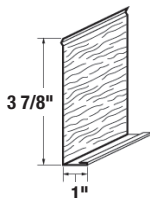

Woodgrain Embossed 6" Fascia Trim

Product Code: F1C6025

Description	Package
Finish: Smooth Acrylic	25 Pcs./Ctn.
Nominal .024" Thick	55 Lbs./Ctn.
Length: 12'	

Color Availability

White, Almond, Autumn Tan, Beige, Black, Canyon, Dark Bronze, Evergreen, Ivory, Jefferson Tan, Khaki, Montana Suede, Musket Brown, Nantucket Gray, Olive, Pewter, Royal Brown, Russet Red, Sand, Slate Blue, Stone Gray, Terra Bronze, Thistle, Wicker



THIS PRODUCT HAS BEEN GREEN APPROVED BY THE NAHB RESEARCH CENTER. This means you can be assured that this product complies with specific green practice criteria in the National Green Building Standard. Visit www.GreenApprovedProducts.com for more details.



Woodgrain Embossed 8" Fascia Trim

Product Code: F1C8025

Description	Package
Finish: Smooth Acrylic	25 Pcs./Ctn.
Nominal .024" Thick	71 Lbs./Ctn.
Length: 12'	

Color Availability

White, Almond, Autumn Tan, Beige, Black, Canyon, Dark Bronze, Evergreen, Ivory, Jefferson Tan, Khaki, Montana Suede, Musket Brown, Nantucket Gray, Olive, Pewter, Royal Brown, Russet Red, Sand, Slate Blue, Stone Gray, Terra Bronze, Thistle, Wicker



THIS PRODUCT HAS BEEN GREEN APPROVED BY THE NAHB RESEARCH CENTER. This means you can be assured that this product complies with specific green practice criteria in the National Green Building Standard. Visit www.GreenApprovedProducts.com for more details.



Woodgrain Embossed 10" Fascia Trim

Product Code: F1C10025

Description	Package
Finish: Smooth Acrylic	25 Pcs./Ctn.
Nominal .024" Thick	85 Lbs./Ctn.
Length: 12'	

Color Availability

White, Almond, Dark Bronze, Ivory, Khaki, Musket Brown, Sand, Terra Bronze, Wicker



THIS PRODUCT HAS BEEN GREEN APPROVED BY THE NAHB RESEARCH CENTER. This means you can be assured that this product complies with specific green practice criteria in the National Green Building Standard. Visit www.GreenApprovedProducts.com for more details.

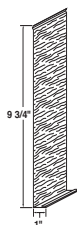

4" Ribbed Fascia .019"

Product Code: **F1C4SR25**

Description	Package
Finish: Smooth Acrylic Nominal .019" Thick Length: 12'	25 Pcs./Ctn. 35 Lbs./Ctn.

Color Availability

White, Almond, Dark Bronze, Ivory, Khaki, Musket Brown, Royal Brown, Sand, Terra Bronze, Wicker



THIS PRODUCT HAS BEEN GREEN APPROVED BY THE NAHB RESEARCH CENTER.
This means you can be assured that this product complies with specific green practice criteria in the National Green Building Standard. Visit www.GreenApprovedProducts.com for more details.

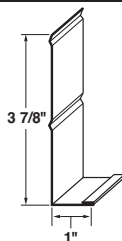

4" Ribbed Fascia .024"

Product Code: **F1C4SR02425**

Description	Package
Finish: Smooth Acrylic Nominal .024" Thick Length: 12'	25 Pcs./Ctn. 41 Lbs./Ctn.

Color Availability

White, Almond, Autumn Tan, Black, Canyon, Dark Bronze, Evergreen, Ivory, Jefferson Tan, Khaki, Montana Suede, Musket Brown, Royal Brown, Sand, Terra Bronze, Wicker



THIS PRODUCT HAS BEEN GREEN APPROVED BY THE NAHB RESEARCH CENTER.
This means you can be assured that this product complies with specific green practice criteria in the National Green Building Standard. Visit www.GreenApprovedProducts.com for more details.

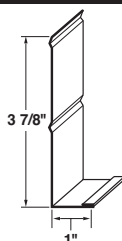

6" Ribbed Fascia .019"

Product Code: **F1C6SR25**

Description	Package
Finish: Smooth Acrylic Nominal .019" Thick Length: 12'	25 Pcs./Ctn. 47 Lbs./Ctn.

Color Availability

White, Almond, Autumn Tan, Beige, Black, Canyon, Dark Bronze, Evergreen, Ivory, Khaki, Montana Suede, Musket Brown, Royal Brown, Russet Red, Sand, Terra Bronze, Wicker



THIS PRODUCT HAS BEEN GREEN APPROVED BY THE NAHB RESEARCH CENTER.
This means you can be assured that this product complies with specific green practice criteria in the National Green Building Standard. Visit www.GreenApprovedProducts.com for more details.

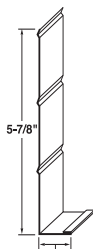

6" Ribbed Fascia .024"

Product Code: **F1C6SR02425**

Description	Package
Finish: Smooth Acrylic Nominal .024" Thick Length: 12'	25 Pcs./Ctn. 55 Lbs./Ctn.

Color Availability

White, Almond, Autumn Tan, Beige, Black, Canyon, Copper Penny, Dark Bronze, Evergreen, Ivory, Jefferson Tan, Khaki, Montana Suede, Musket Brown, Nantucket Gray, Olive, Pewter, Royal Brown, Russet Red, Sand, Slate Blue, Stone Gray, Terra Bronze, Thistle, Wicker



THIS PRODUCT HAS BEEN GREEN APPROVED BY THE NAHB RESEARCH CENTER.
This means you can be assured that this product complies with specific green practice criteria in the National Green Building Standard. Visit www.GreenApprovedProducts.com for more details.

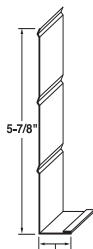

8" Ribbed Fascia .019"

Product Code: **F1C8SR25**

Description	Package
Finish: Smooth Acrylic	25 Pcs./Ctn.
Nominal .019" Thick	59 Lbs./Ctn.
Length: 12'	

Color Availability

White, Almond, Autumn Tan, Beige, Black, Canyon, Dark Bronze, Evergreen, Ivory, Khaki, Montana Suede, Musket Brown, Royal Brown, Russet Red, Sand, Terra Bronze, Wicker



THIS PRODUCT HAS BEEN GREEN APPROVED BY THE NAHB RESEARCH CENTER. This means you can be assured that this product complies with specific green practice criteria in the National Green Building Standard. Visit www.GreenApprovedProducts.com for more details.

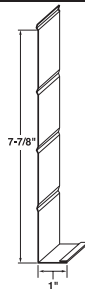

8" Ribbed Fascia .024"

Product Code: **F1C8SR02425**

Description	Package
Finish: Smooth Acrylic	25 Pcs./Ctn.
Nominal .024" Thick	71 Lbs./Ctn.
Length: 12'	

Color Availability

White, Almond, Autumn Tan, Beige, Black, Canyon, Copper Penny, Dark Bronze, Evergreen, Ivory, Jefferson Tan, Khaki, Montana Suede, Musket Brown, Nantucket Gray, Olive, Pewter, Royal Brown, Russet Red, Sand, Slate Blue, Stone Gray, Terra Bronze, Thistle, Wicker



THIS PRODUCT HAS BEEN GREEN APPROVED BY THE NAHB RESEARCH CENTER. This means you can be assured that this product complies with specific green practice criteria in the National Green Building Standard. Visit www.GreenApprovedProducts.com for more details.

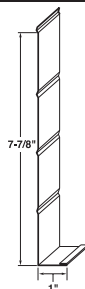

10" Ribbed Fascia .019"

Product Code: **F1C10SR25**

Description	Package
Finish: Smooth Acrylic	25 Pcs./Ctn.
Nominal .019" Thick	72 Lbs./Ctn.
Length: 12'	

Color Availability

White, Khaki, Musket Brown, Wicker



THIS PRODUCT HAS BEEN GREEN APPROVED BY THE NAHB RESEARCH CENTER. This means you can be assured that this product complies with specific green practice criteria in the National Green Building Standard. Visit www.GreenApprovedProducts.com for more details.

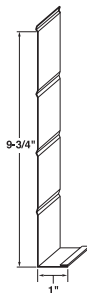

10" Ribbed Fascia .024"

Product Code: **F1C10SR02425**

Description	Package
Finish: Smooth Acrylic	25 Pcs./Ctn.
Nominal .024" Thick	85 Lbs./Ctn.
Length: 12'	

Color Availability

White, Almond, Dark Bronze, Ivory, Khaki, Musket Brown, Sand, Terra Bronze, Wicker



THIS PRODUCT HAS BEEN GREEN APPROVED BY THE NAHB RESEARCH CENTER. This means you can be assured that this product complies with specific green practice criteria in the National Green Building Standard. Visit www.GreenApprovedProducts.com for more details.

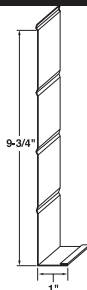

ALUMINUM ACCESSORIES

General Purpose Trim

Product Code: **4APN20**

Description

Finish: Smooth Acrylic
Nominal .019" Thick
Length: 12' 6"

Package

20 Pcs./Ctn.
14.3 Lbs./Ctn.

Color Availability

White, Almond, Autumn Tan, Beige, Black, Canyon, Dark Bronze, Evergreen, Ivory, Khaki, Montana Suede, Musket Brown, Olive, Pewter, Royal Brown, Russet Red, Sand, Slate Blue, Terra Bronze, Wicker



THIS PRODUCT HAS BEEN GREEN APPROVED BY THE NAHB RESEARCH CENTER. This means you can be assured that this product complies with specific green practice criteria in the National Green Building Standard. Visit www.GreenApprovedProducts.com for more details.

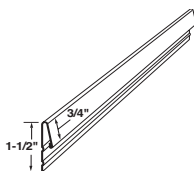

Quarter-Round Molding

Product Code: **F338S**

Description

Finish: Smooth Acrylic
Nominal .019" Thick
Length: 12' 1"

Package

24 Pcs./Ctn.
34 Lbs./Ctn.

Color Availability

White, Musket Brown

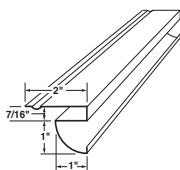

3/8" J-Channel

Product Code: **F438425**

Description

Finish: Smooth Acrylic
Nominal .016" Thick
Length: 12'

Package

25 Pcs./Ctn.
19 Lbs./Ctn.

Color Availability

White, Almond, Autumn Tan, Beige, Black, Canyon, Dark Bronze, Evergreen, Jefferson Tan, Ivory, Khaki, Montana Suede, Musket Brown, Nantucket Gray, Olive, Pewter, Royal Brown, Russet Red, Sand, Slate Blue, Stone Gray, Terra Bronze, Thistle, Wicker

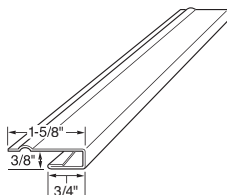

1/2" J-Channel

Product Code: **SJ1625**

Description

Finish: Smooth Acrylic
Nominal .016" Thick
Length: 12'

Package

25 Pcs./Ctn.
18 Lbs./Ctn.

Color Availability

White, Almond, Autumn Tan, Beige, Black, Canyon, Dark Bronze, Evergreen, Ivory, Khaki, Musket Brown, Royal Brown, Terra Bronze, Wicker

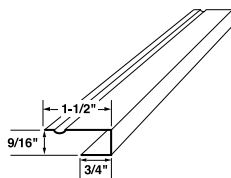

ALUMINUM ACCESSORIES

5/8" J-Channel

Product Code: 58ALJ25

Description

Finish: Smooth Acrylic
Nominal .019" Thick
Length: 12'

Package

25 Pcs./Ctn.
24.3 Lbs./Ctn.

Color Availability

White, Almond, Autumn Tan, Beige, Canyon, Ivory, Khaki, Montana Suede, Musket Brown, Nantucket Gray, Pewter, Sand, Slate Blue, Stone Gray, Thistle, Wicker

Note: For use with vinyl soffit.

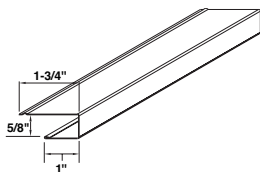

3/8" F-Channel

Product Code: F8S25

Description

Finish: Smooth Acrylic
Nominal .019" Thick
Length: 12'

Package

25 Pcs./Ctn.
37 Lbs./Ctn.

Color Availability

White, Almond, Autumn Tan, Beige, Black, Canyon, Dark Bronze, Evergreen, Ivory, Jefferson Tan, Khaki, Montana Suede, Musket Brown, Nantucket Gray, Olive, Pewter, Royal Brown, Sand, Slate Blue, Stone Gray, Terra Bronze, Thistle, Wicker

Note: For use with 3/8" soffit.

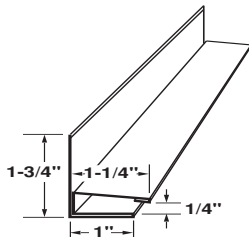

THIS PRODUCT HAS BEEN GREEN APPROVED BY THE NAHB RESEARCH CENTER. This means you can be assured that this product complies with specific green practice criteria in the National Green Building Standard. Visit www.GreenApprovedProducts.com for more details.

1/2" F-Channel

Product Code: F12

Description

Finish: Smooth Acrylic
Nominal .016" Thick
Length: 12'

Package

25 Pcs./Ctn.
20 Lbs./Ctn.

Color Availability

White, Musket Brown

Note: For use with 1/2" soffit.

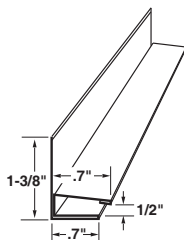

THIS PRODUCT HAS BEEN GREEN APPROVED BY THE NAHB RESEARCH CENTER. This means you can be assured that this product complies with specific green practice criteria in the National Green Building Standard. Visit www.GreenApprovedProducts.com for more details.

5/8" F-Channel

Product Code: SF58

Description

Finish: Smooth Acrylic
Nominal .019" Thick
Length: 12' 1"

Package

24 Pcs./Ctn.
38 Lbs./Ctn.

Color Availability

White, Almond, Ivory, Khaki, Wicker

Note: For use with 5/8" soffit.

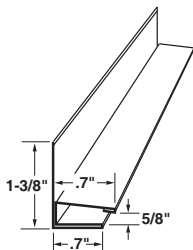

THIS PRODUCT HAS BEEN GREEN APPROVED BY THE NAHB RESEARCH CENTER. This means you can be assured that this product complies with specific green practice criteria in the National Green Building Standard. Visit www.GreenApprovedProducts.com for more details.

3/8" T-Channel

Product Code: **SAT38**

Description	Package
Finish: Smooth Acrylic	10 Pcs./Ctn.
Nominal .019" Thick	20 Lbs./Ctn.
Length: 10'	

Color Availability

White, Almond, Autumn Tan, Beige, Black, Canyon, Dark Bronze, Evergreen, Jefferson Tan, Ivory, Khaki, Montana Suede, Musket Brown, Royal Brown, Stone Gray, Terra Bronze, Wicker

Note: For use with 3/8" aluminum soffit.

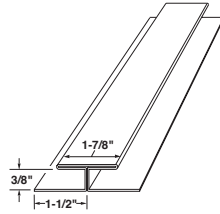

Heavy-Duty Metal Starter Strip (Galvanized)

Product Code: **CPSSHD**

Description	Package
Finish: Mill	25 Pcs./Ctn.
Length: 10'	49 Lbs./Ctn.

Color Availability

No color

Note: For use with Cedar Dimensions Shingle and Round Cut Siding Panels.



THIS PRODUCT HAS BEEN GREEN APPROVED BY THE NAHB RESEARCH CENTER.
This means you can be assured that this product complies with specific green practice criteria in the National Green Building Standard. Visit www.GreenApprovedProducts.com for more details.

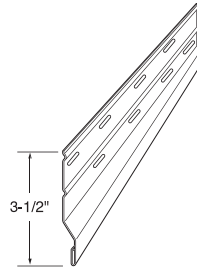

Galvanized Steel Starter Strip

Product Code: **ASVSS25**

Description	Package
Finish: Mill	25 Pcs./Ctn.
Length: 10'	42 Lbs./Ctn.

Color Availability

No color



THIS PRODUCT HAS BEEN GREEN APPROVED BY THE NAHB RESEARCH CENTER.
This means you can be assured that this product complies with specific green practice criteria in the National Green Building Standard. Visit www.GreenApprovedProducts.com for more details.

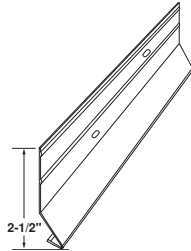

LEAF RELIEF® GUTTER PROTECTION SYSTEM

5" Combo Hanger

Product Code: SN5200S

Description

Length: 7' 6"

Package

48 Pcs./Ctn.
59.4 Lbs./Ctn.
360 Ft./Ctn.

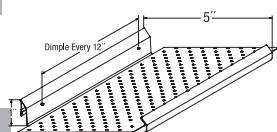

Color Availability

Matte Gold



THIS PRODUCT HAS BEEN GREEN APPROVED BY THE NAHB RESEARCH CENTER. This means you can be assured that this product complies with specific green practice criteria in the National Green Building Standard. Visit www.GreenApprovedProducts.com for more details.

5" Classic

Product Code: TP5300

Description

Length: 10'

Package

32 Pcs./Ctn.
320'/Ctn.
48.6 Lbs./Ctn.

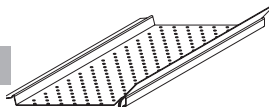

Color Availability

Matte Gold

Note: Fits over existing 5" OG and K-style aluminum gutters.



THIS PRODUCT HAS BEEN GREEN APPROVED BY THE NAHB RESEARCH CENTER. This means you can be assured that this product complies with specific green practice criteria in the National Green Building Standard. Visit www.GreenApprovedProducts.com for more details.

5" Zip

Product Code: TP53ZIP

Description

Length: 10'

Package

32 Pcs./Ctn.
320'/Ctn.
51.8 Lbs./Ctn.

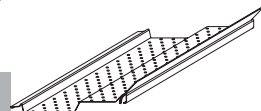

Color Availability

Matte Gold



THIS PRODUCT HAS BEEN GREEN APPROVED BY THE NAHB RESEARCH CENTER. This means you can be assured that this product complies with specific green practice criteria in the National Green Building Standard. Visit www.GreenApprovedProducts.com for more details.

LEAF RELIEF® GUTTER PROTECTION SYSTEM

5" Adjustable

Product Code: **TP5100Q**

Description

Length: 7' 6"

Package

16 Pcs./Ctn.

120'/Ctn.

22 Lbs./Ctn.

Color Availability

Matte Gold

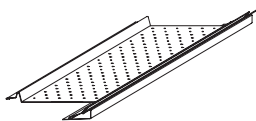

THIS PRODUCT HAS BEEN GREEN APPROVED BY THE NAHB RESEARCH CENTER.

This means you can be assured that this product complies with specific green practice criteria in the National Green Building Standard. Visit www.GreenApprovedProducts.com for more details.

5" Adjustable Copper

Product Code: **TPC5100**

Description

Length: 7' 6"

Package

16 Pcs./Ctn.

120'/Ctn.

71.6 Lbs./Ctn.

Color Availability

Copper

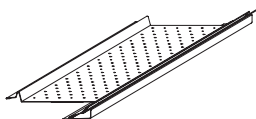

Note: Copper screws included. Use only with K or OG-style copper gutters. One carton minimum order required. Call for pricing and lead time.



THIS PRODUCT HAS BEEN GREEN APPROVED BY THE NAHB RESEARCH CENTER.

This means you can be assured that this product complies with specific green practice criteria in the National Green Building Standard. Visit www.GreenApprovedProducts.com for more details.

LEAF RELIEF® GUTTER PROTECTION SYSTEM

5" Half-Round

Product Code: **HR5400**

Description

Length: 7' 6"

Package

16 Pcs./Ctn.
120/Ctn.
22.6 Lbs./Ctn.



Color Availability

Matte Gold



THIS PRODUCT HAS BEEN GREEN APPROVED BY THE NAHB RESEARCH CENTER. This means you can be assured that this product complies with specific green practice criteria in the National Green Building Standard. Visit www.GreenApprovedProducts.com for more details.

5" Half-Round Copper

Product Code: **HRC5400**

Description

Length: 7' 6"

Package

16 Pcs./Ctn.
120/Ctn.
56.5 Lbs./Ctn.



Color Availability

Copper

Note: Copper screws included. Use only with 5" half-round copper gutters. One carton minimum order required. Call for pricing and lead time.



THIS PRODUCT HAS BEEN GREEN APPROVED BY THE NAHB RESEARCH CENTER. This means you can be assured that this product complies with specific green practice criteria in the National Green Building Standard. Visit www.GreenApprovedProducts.com for more details.

5" Outside Corners

Product Code: **OC5220**

Description

Package

20 Complete Corners/Ctn.
3.4 Lbs./Ctn.

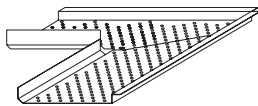

Color Availability

Matte Gold



THIS PRODUCT HAS BEEN GREEN APPROVED BY THE NAHB RESEARCH CENTER. This means you can be assured that this product complies with specific green practice criteria in the National Green Building Standard. Visit www.GreenApprovedProducts.com for more details.

Note: Use with TP5100Q or TP5300.

5" Inside Corners

Product Code: **IC5220**

Description

Package

20 Complete Corners/Ctn.
3.4 Lbs./Ctn.

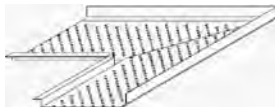

Color Availability

Matte Gold



THIS PRODUCT HAS BEEN GREEN APPROVED BY THE NAHB RESEARCH CENTER. This means you can be assured that this product complies with specific green practice criteria in the National Green Building Standard. Visit www.GreenApprovedProducts.com for more details.

Note: Use with TP5100Q or TP5300.

6" Combo Hanger

Product Code: **SN6200S**

Description

Finish: Smooth Polymer
Nominal .019" Thick
Length: 7' 6"

Package

34 Pcs./Ctn.
49.4 Lbs./Ctn.
255 Ft./Ctn.

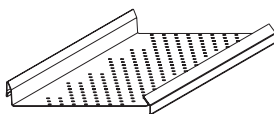

Color Availability

Matte Gold



THIS PRODUCT HAS BEEN GREEN APPROVED BY THE NAHB RESEARCH CENTER.
This means you can be assured that this product complies with specific green practice criteria in the National Green Building Standard. Visit www.GreenApprovedProducts.com for more details.

6" Classic

Product Code: **TP6300**

Description

Length: 10'

Package

32 Pcs./Ctn.
320'/Ctn.
55.4 Lbs./Ctn.

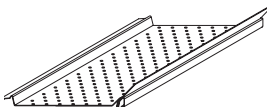

Color Availability

Matte Gold



THIS PRODUCT HAS BEEN GREEN APPROVED BY THE NAHB RESEARCH CENTER.
This means you can be assured that this product complies with specific green practice criteria in the National Green Building Standard. Visit www.GreenApprovedProducts.com for more details.

Note: Fits over existing 6" OG and K-style aluminum gutters.

6" Zip

Product Code: **TP63ZIP**

Description

Length: 10'

Package

32 Pcs./Ctn.
320'/Ctn.
57.6 Lbs./Ctn.

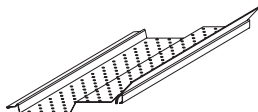

Color Availability

Matte Gold



THIS PRODUCT HAS BEEN GREEN APPROVED BY THE NAHB RESEARCH CENTER.
This means you can be assured that this product complies with specific green practice criteria in the National Green Building Standard. Visit www.GreenApprovedProducts.com for more details.

6" Adjustable Copper

Product Code: **TPC6100**

Description

Length: 7' 6"

Package

16 Pcs./Ctn.
120'/Ctn.
75.0 Lbs./Ctn.

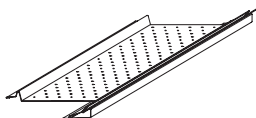

Color Availability

Copper



THIS PRODUCT HAS BEEN GREEN APPROVED BY THE NAHB RESEARCH CENTER.
This means you can be assured that this product complies with specific green practice criteria in the National Green Building Standard. Visit www.GreenApprovedProducts.com for more details.

Note: Copper screws included. Use only with K or OG-style copper gutters. One carton minimum order required. Call for pricing and lead time.

LEAF RELIEF® GUTTER PROTECTION SYSTEM

6" Half-Round

Product Code: HR6400

Description

Length: 7' 6"

Package

16 Pcs./Ctn.
120'/Ctn.
25.4 Lbs./Ctn.

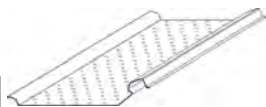

Color Availability

Matte Gold



THIS PRODUCT HAS BEEN GREEN APPROVED BY THE NAHB RESEARCH CENTER. This means you can be assured that this product complies with specific green practice criteria in the National Green Building Standard. Visit www.GreenApprovedProducts.com for more details.

6" Half-Round Copper

Product Code: HRC6400

Description

Length: 7' 6"

Package

16 Pcs./Ctn.
120'/Ctn.
63.0 Lbs./Ctn.



Color Availability

Copper



THIS PRODUCT HAS BEEN GREEN APPROVED BY THE NAHB RESEARCH CENTER. This means you can be assured that this product complies with specific green practice criteria in the National Green Building Standard. Visit www.GreenApprovedProducts.com for more details.

Note: Copper screws included. Use only with 6" half-round copper gutters.

6" Outside Corners

Product Code: OC6220

Description

Package

20 Complete Corners/Ctn.
3.8 Lbs./Ctn.

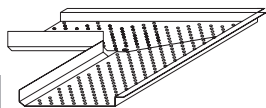

Color Availability

Matte Gold



THIS PRODUCT HAS BEEN GREEN APPROVED BY THE NAHB RESEARCH CENTER. This means you can be assured that this product complies with specific green practice criteria in the National Green Building Standard. Visit www.GreenApprovedProducts.com for more details.

Note: Use with TP6300.

6" Inside Corners

Product Code: IC6220

Description

Package

20 Complete Corners/Ctn.
3.8 Lbs./Ctn.

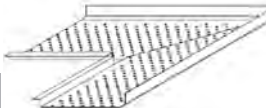

Color Availability

Matte Gold



THIS PRODUCT HAS BEEN GREEN APPROVED BY THE NAHB RESEARCH CENTER. This means you can be assured that this product complies with specific green practice criteria in the National Green Building Standard. Visit www.GreenApprovedProducts.com for more details.

Note: Use with TP6300.

5" Rippled Plate

Product Code: **LL510**

Description

Length: 10'

Package

30 Pcs./Ctn.
300 Ft./Ctn.
30 Lbs./Ctn.

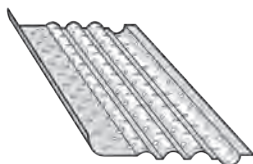

Color Availability

Brushed Nickel
Dark Bronze
White



THIS PRODUCT HAS BEEN GREEN APPROVED BY THE NAHB RESEARCH CENTER.
This means you can be assured that this product complies with specific green practice criteria in the National Green Building Standard. Visit www.GreenApprovedProducts.com for more details.

6" Rippled Plate

Product Code: **LL610**

Description

Length: 10'

Package

30 Pcs./Ctn.
300 Ft./Ctn.
35 Lbs./Ctn.



Color Availability

Brushed Nickel
Dark Bronze
White



THIS PRODUCT HAS BEEN GREEN APPROVED BY THE NAHB RESEARCH CENTER.
This means you can be assured that this product complies with specific green practice criteria in the National Green Building Standard. Visit www.GreenApprovedProducts.com for more details.

Valley Water Diverter/Deflector

Product Code: ASDIV

Description

Package

30 Pcs./Ctn.
1.6 Lbs./Ctn.

Color Availability

(11) Paintable version available

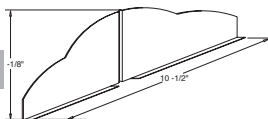

Note: Required atop all inside corners.

#6 x 3/8" Stainless Steel Screw Pan Head with Square Slot

Product Code: SQ6X038

Description

Package

1,000 per Carton
100/Bag
10 Bags/Ctn.
2 Lbs./Ctn.

Color Availability

No color

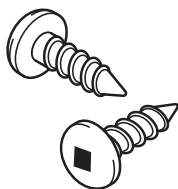

Note: Use with TP5100P, TP5300, and TP6300 Systems.



THIS PRODUCT HAS BEEN GREEN APPROVED BY THE NABIS RESEARCH CENTER. This means you can be assured that this product complies with specific green practice criteria in the National Green Building Standards. Visit www.GreenApprovedProducts.com for more details.

#9 x 1 1/2" Hex-Head Screw with Gasket

Product Code: SC9X150

Description

Package

1,000 per Carton
100/Bag
10 Bags/Ctn.
2 Lbs./Ctn.

Color Availability

No color



Note: Use with SN5200S and SN6200S Systems.



THIS PRODUCT HAS BEEN GREEN APPROVED BY THE NABIS RESEARCH CENTER. This means you can be assured that this product complies with specific green practice criteria in the National Green Building Standards. Visit www.GreenApprovedProducts.com for more details.

T-Drip

Product Code	Description	Face Length	Top Length	Part Length	Material	Finish	Nominal Thickness / Gauge	Pcs/ Ctn	Lbs/ Ctn	Color Group
TD1029L	T-Drip 1x2-7/8 Light	1"	2-7/8"	10'	Aluminum	Acrylic	0.013	25	15.8	1
TD1029	T-Drip 1x2-7/8	1"	2-7/8"	10'	Aluminum	Acrylic	0.016	25	19.2	4
TD1029H	T-Drip 1x2-7/8 Heavy	1"	2-7/8"	10'	Aluminum	Acrylic	0.019	25	22.5	1
TD1029S	T-Drip 1x2-7/8 Galvanized	1"	2-7/8"	10'	Galvanized Steel	Polyester	0.016	25	51.1	2
TD1529	T-Drip 1-1/2x2-7/8	1-1/2"	2-7/8"	10'	Aluminum	Acrylic	0.016	25	21.6	1
TD1529H	T-Drip 1-1/2x2-7/8 Heavy	1-1/2"	2-7/8"	10'	Aluminum	Acrylic	0.019	25	25.2	5
TD1529H12	T-Drip 1-1/2x2-7/8x12' Heavy	1-1/2"	2-7/8"	12'	Aluminum	Acrylic	0.019	25	30.3	5
TD1529S	T-Drip 1x2-7/8 Galvanized	1-1/2"	2-7/8"	10'	Galvanized Steel	Polyester	0.016	25	57.4	3
TD1549H	T-Drip 1-1/2x4-7/8 Heavy	1-1/2"	4-7/8"	10'	Aluminum	Acrylic	0.019	25	35.5	1
TD1829	T-Drip 1-3/4x2-7/8	1-3/4"	2-7/8"	10'	Aluminum	Acrylic	0.016	25	22.5	4
TD1829H	T-Drip 1-3/4x2-7/8 Heavy	1-3/4"	2-7/8"	10'	Aluminum	Acrylic	0.019	25	26.4	5
TD1829S	T-Drip 1-3/4x2-7/8 Galvanized	1-3/4"	2-7/8"	10'	Galvanized Steel	Polyester	0.016	25	59.9	3
TD2029H	T-Drip 2x2-7/8 Heavy	2"	2-7/8"	10'	Aluminum	Acrylic	0.019	25	28.3	1

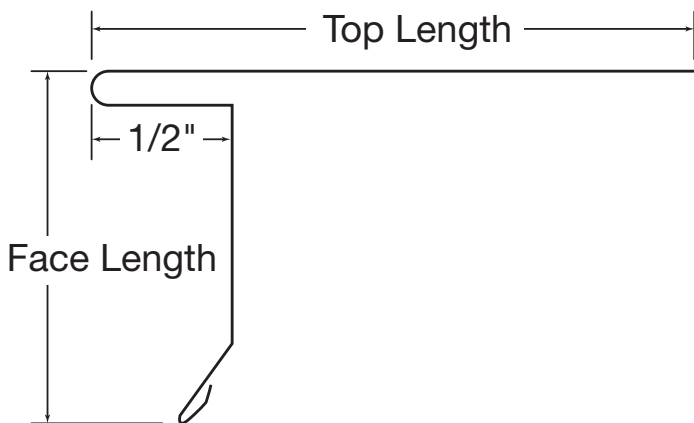

Color Group 1	White, Black, Dark Bronze, Musket Brown, Pebblestone Clay, Royal Brown, Terra Bronze
Color Group 2	Mill, White, Black, Dark Bronze, Musket Brown, Pebblestone Clay, Royal Brown, Terra Bronze
Color Group 3	Mill, White, Almond, Black, Cameo, Charcoal Grey, Desert Sand, Jefferson Tan, Montana Suede, Pebblestone Clay, Royal Brown, Sandtone, Terra Bronze, Wicker
Color Group 4	White, Almond, Black, Cameo, Dark Bronze, Musket Brown, Pebblestone Clay, Royal Brown, Terra Bronze, Wicker
Color Group 5	White, Almond, Black, Cameo, Charcoal Grey, Cream, Dark Bronze, Desert Sand, Evergreen, Jefferson Tan, Linen, London Brown, Montana Suede, Musket Brown, Pebblestone Clay, Royal Brown, Rugged Canyon, Russet Red, Sandtone, Silver Grey, Terra Bronze, Victorian Grey, Wicker

ROOFING ACCESSORIES

F-Drip

Product Code	Description	Face Length	Top Length	Part Length	Material	Finish	Nominal Thickness / Gauge	Pcs/ Ctn	Lbs/ Ctn	Color Group
FD1060H	F-Drip 1x6 Heavy	1"	6"	10'	Aluminum	Acrylic	0.019	25	35.5	1
FD1060S	F-Drip 1x6 Galvanized	1"	6"	10'	Galvanized Steel	Polyester	0.016	25	80.6	2
FD202012	F-Drip 2x2	2"	2"	12'	Aluminum	Acrylic	0.016	25	23	4
FD2020H12	F-Drip 2x2x12' Heavy	2"	2"	12'	Aluminum	Acrylic	0.019	25	27	1
FD2020S	F-Drip 2x2 Galvanized	2"	2"	12'	Galvanized Steel	Polyester	0.016	25	61.4	2
FD2028	F-Drip 2x2-3/4	2"	2-3/4"	10'	Aluminum	Acrylic	0.016	25	22.5	1
FD2028H	F-Drip 2x2-3/4 Heavy	2"	2-3/4"	10'	Aluminum	Acrylic	0.019	25	26.5	5
FD2028S	F-Drip 2x2-3/4 Galvanized	2"	2-3/4"	10'	Galvanized Steel	Polyester	0.016	25	59.9	3

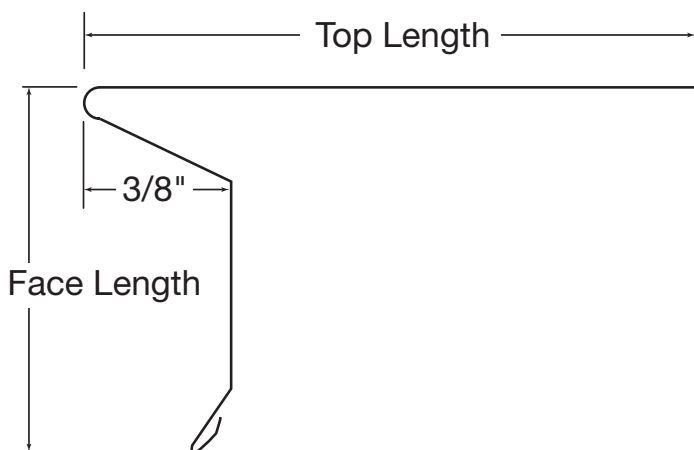

Color Group 1	White, Black, Dark Bronze, Musket Brown, Pebblestone Clay, Royal Brown, Terra Bronze
Color Group 2	Mill, White, Black, Dark Bronze, Musket Brown, Pebblestone Clay, Royal Brown, Terra Bronze
Color Group 3	Mill, White, Almond, Black, Cameo, Charcoal Grey, Desert Sand, Jefferson Tan, Montana Suede, Pebblestone Clay, Royal Brown, Sandtone, Terra Bronze, Wicker
Color Group 4	White, Almond, Black, Cameo, Dark Bronze, Musket Brown, Pebblestone Clay, Royal Brown, Terra Bronze, Wicker
Color Group 5	White, Almond, Black, Cameo, Charcoal Grey, Cream, Dark Bronze, Desert Sand, Evergreen, Jefferson Tan, Linen, London Brown, Montana Suede, Musket Brown, Pebblestone Clay, Royal Brown, Rugged Canyon, Russet Red, Sandtone, Silver Grey, Terra Bronze, Victorian Grey, Wicker

C-Drip

Product Code	Description	Face Length	Top Length	Bottom Length	Part Length	Material	Finish	Nominal Thickness / Gauge	Pcs/ Ctn	Lbs/ Ctn	Color Group
CD1028H	C-Drip 1x2-3/4 Heavy	1"	2-3/4"	1-1/8"	10'	Aluminum	Acrylic	0.019	25	26.4	5
CD1028S	C-Drip 1x2-3/4 Galvanized	1"	2-3/4"	1-1/8"	10'	Galvanized Steel	Polyester	0.016	25	59.9	3
CD1528H	C-Drip 1-1/2x2-3/4 Heavy	1-1/2"	2-3/4"	1-1/8"	10'	Aluminum	Acrylic	0.019	25	28.3	1
CD1528S	C-Drip 1-1/2x2-3/4 Galvanized	1-1/2"	2-3/4"	1-1/8"	10'	Galvanized Steel	Polyester	0.016	25	64.3	2
CD2028H	C-Drip 2x2-3/4 Heavy	2"	2-3/4"	1-1/8"	10'	Aluminum	Acrylic	0.019	25	31	1
CD2028S	C-Drip 2x2-3/4 Galvanized	2"	2-3/4"	1-1/8"	10'	Galvanized Steel	Polyester	0.016	25	70.4	2

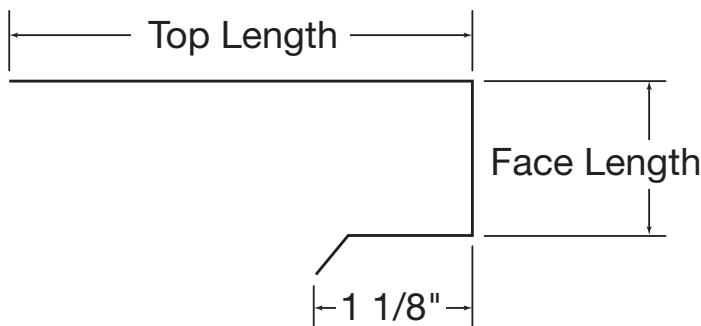

Color Group 1	White, Black, Dark Bronze, Musket Brown, Pebblestone Clay, Royal Brown, Terra Bronze
Color Group 2	Mill, White, Black, Dark Bronze, Musket Brown, Pebblestone Clay, Royal Brown, Terra Bronze
Color Group 3	Mill, White, Almond, Black, Cameo, Charcoal Grey, Desert Sand, Jefferson Tan, Montana Suede, Pebblestone Clay, Royal Brown, Sandtone, Terra Bronze, Wicker
Color Group 4	White, Almond, Black, Cameo, Dark Bronze, Musket Brown, Pebblestone Clay, Royal Brown, Terra Bronze, Wicker
Color Group 5	White, Almond, Black, Cameo, Charcoal Grey, Cream, Dark Bronze, Desert Sand, Evergreen, Jefferson Tan, Linen, London Brown, Montana Suede, Musket Brown, Pebblestone Clay, Royal Brown, Rugged Canyon, Russet Red, Sandtone, Silver Grey, Terra Bronze, Victorian Grey, Wicker

Square Drip / Gutter Apron

Product Code	Description	Face Length	Top Length	Part Length	Material	Finish	Nominal Thickness / Gauge	Pcs/ Ctn	Lbs/ Ctn	Color Group
SD1515H	Sq Drip 1-1/2x1-1/2 Heavy	1-1/2"	1-1/2"	10'	Aluminum	Acrylic	0.019	25	20.5	1
SD2025H	Sq Drip 2x2-1/2 Heavy	2"	2-1/2"	10'	Aluminum	Acrylic	0.016	25	25.2	1
SD2025SD	Sq Drip 2x2-1/2 Galvanized	2"	2-1/2"	10'	Galvanized Steel	Polyester	0.016	25	57.4	2

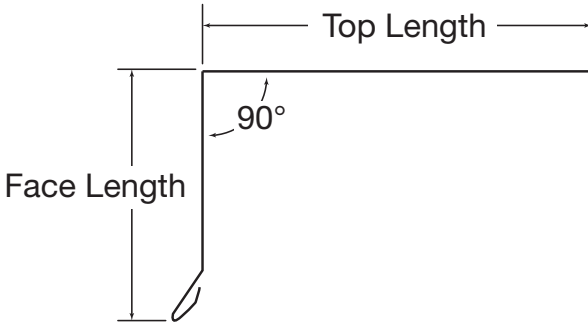

Product Code	Description	Face Length	Top Length	Part Length	Material	Finish	Nominal Thickness / Gauge	Pcs/ Ctn	Lbs/ Ctn	Color Group
GA2029H	Apron 2x2-7/8" Heavy	2"	2-7/8"	10'	Aluminum	Acrylic	0.019	25	25.2	5
GA2029S	Apron 2x2-7/8" Galvanized	2"	2-7/8"	10'	Galvanized Steel	Polyester	0.016	25	57.4	3

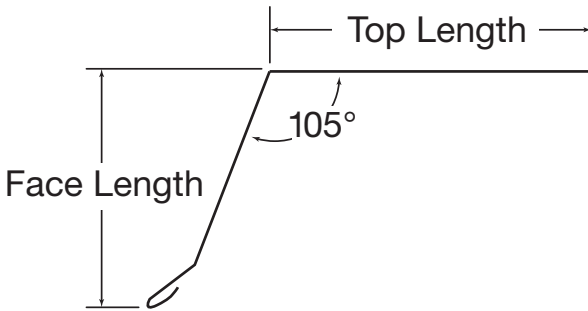

Color Group 1	White, Black, Dark Bronze, Musket Brown, Pebblestone Clay, Royal Brown, Terra Bronze
Color Group 2	Mill, White, Black, Dark Bronze, Musket Brown, Pebblestone Clay, Royal Brown, Terra Bronze
Color Group 3	Mill, White, Almond, Black, Cameo, Charcoal Grey, Desert Sand, Jefferson Tan, Montana Suede, Pebblestone Clay, Royal Brown, Sandtone, Terra Bronze, Wicker
Color Group 4	White, Almond, Black, Cameo, Dark Bronze, Musket Brown, Pebblestone Clay, Royal Brown, Terra Bronze, Wicker
Color Group 5	White, Almond, Black, Cameo, Charcoal Grey, Cream, Dark Bronze, Desert Sand, Evergreen, Jefferson Tan, Linen, London Brown, Montana Suede, Musket Brown, Pebblestone Clay, Royal Brown, Rugged Canyon, Russet Red, Sandtone, Silver Grey, Terra Bronze, Victorian Grey, Wicker

Quick Drip / Gravel Stop

Product Code	Description	Face Length	Top Length	Part Length	Material	Finish	Nominal Thickness / Gauge	Pcs/ Ctn	Lbs/ Ctn	Color Group
QD2410H12	Quick Drip 2-7/16x1x12' Heavy	2-7/16"	1"	12'	Aluminum	Acrylic	0.019	25	20.5	5

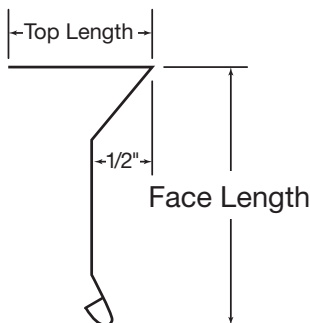

Product Code	Description	Face Length	Top Length	Part Length	Material	Finish	Nominal Thickness / Gauge	Pcs/ Ctn	Lbs/ Ctn	Color Group
GS4029XH	Gravel Stop 4x4 Extra Heavy	4"	4"	10'	Aluminum	Acrylic	0.024	25	25.2	1

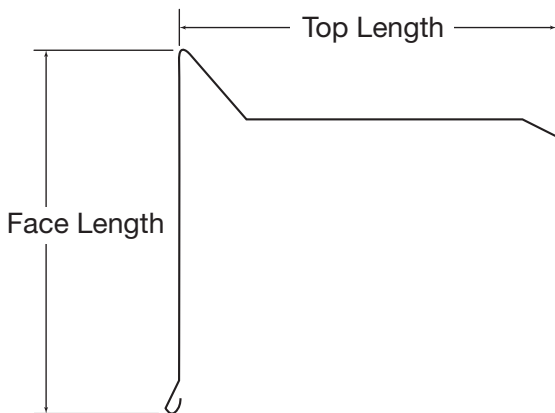

Color Group 1	White, Black, Dark Bronze, Musket Brown, Pebblestone Clay, Royal Brown, Terra Bronze
Color Group 2	Mill, White, Black, Dark Bronze, Musket Brown, Pebblestone Clay, Royal Brown, Terra Bronze
Color Group 3	Mill, White, Almond, Black, Cameo, Charcoal Grey, Desert Sand, Jefferson Tan, Montana Suede, Pebblestone Clay, Royal Brown, Sandtone, Terra Bronze, Wicker
Color Group 4	White, Almond, Black, Cameo, Dark Bronze, Musket Brown, Pebblestone Clay, Royal Brown, Terra Bronze, Wicker
Color Group 5	White, Almond, Black, Cameo, Charcoal Grey, Cream, Dark Bronze, Desert Sand, Evergreen, Jefferson Tan, Linen, London Brown, Montana Suede, Musket Brown, Pebblestone Clay, Royal Brown, Rugged Canyon, Russet Red, Sandtone, Silver Grey, Terra Bronze, Victorian Grey, Wicker

Flat Flashing Squares

Product Code	Description	A Length	B Length	C Length	Material	Finish	Nominal Thickness / Gauge	Pcs/ Ctn	Lbs/ Ctn	Color Group
FF57	Flat Square 5x7	5"	7"	n/a	Aluminum	Acrylic	0.013	500	21.1	0
FF57S	Flat Square 5x7 Galvanized	5"	7"	n/a	Galvanized Steel	Polyester	0.016	100	13.6	0
FF68	Flat Square 6x8	6"	8"	n/a	Aluminum	Acrylic	0.013	500	29	0
FF68S	Flat Square 6x8 Galvanized	6"	8"	n/a	Galvanized Steel	Polyester	0.016	100	18.6	0
FF77	Flat Square 7x7	7"	7"	n/a	Aluminum	Acrylic	0.013	500	29.5	0
FF77S	Flat Square 7x7 Galvanized	7"	7"	n/a	Galvanized Steel	Polyester	0.016	100	19	0
FF88	Flat Square 8x8	8"	8"	n/a	Aluminum	Acrylic	0.013	500	38.6	0
FF88S	Flat Square 8x8 Galvanized	8"	8"	n/a	Galvanized Steel	Polyester	0.016	100	24.8	0

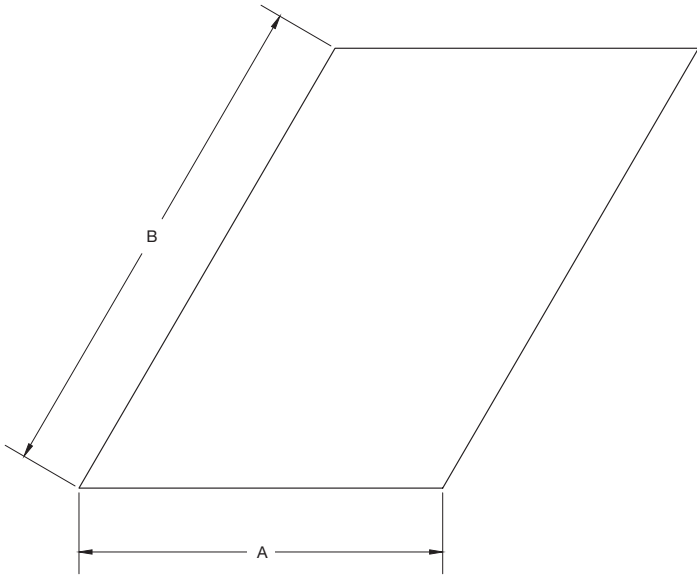

Color Group 0 | Mill, White/Black, Royal Brown/Terra Bronze

Color Group 1 | Mill, White, Black, Royal Brown, Terra Bronze

Prebent Flashing Squares

Product Code	Description	A Length	B Length	C Length	Material	Finish	Nominal Thickness / Gauge	Pcs/ Ctn	Lbs/ Ctn	Color Group
PBF237	Prebent Square 2x3x7	2"	3"	7"	Aluminum	Acrylic	0.013	500	21.1	1
PBF237S	Prebent Square 2x3x7 Galvanized	2"	3"	7"	Galvanized Steel	Polyester	0.016	100	13.6	1
PBF338	Prebent Square 3x3x8	3"	3"	8"	Aluminum	Acrylic	0.013	500	29	1
PBF338S	Prebent Square 3x3x8 Galvanized	3"	3"	8"	Galvanized Steel	Polyester	0.016	100	18.6	1
PBF347	Prebent Square 3x4x7	3"	4"	7"	Aluminum	Acrylic	0.013	500	29.5	1
PBF347S	Prebent Square 3x4x7 Galvanized	3"	4"	7"	Galvanized Steel	Polyester	0.016	100	19	1
PBF448	Prebent Square 4x4x8	4"	4"	8"	Aluminum	Acrylic	0.013	500	38.6	1
PBF448S	Prebent Square 4x4x8 Galvanized	4"	4"	8"	Galvanized Steel	Polyester	0.016	100	24.8	1

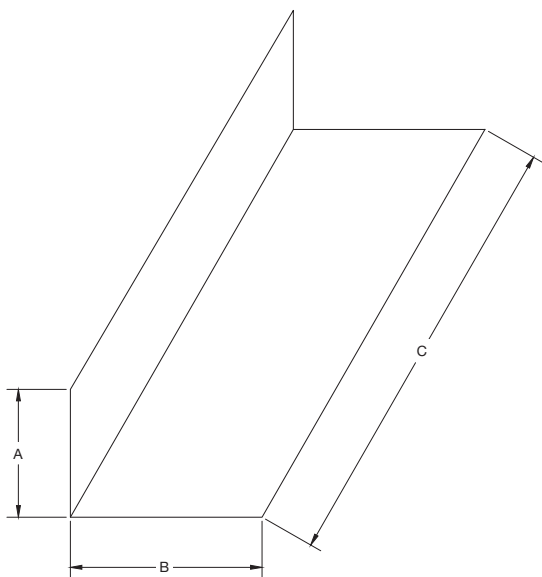

Color Group 0 | Mill, White/Black, Royal Brown/Terra Bronze

Color Group 1 | Mill, White, Black, Royal Brown, Terra Bronze

ROOFING ACCESSORIES

W-Valley

Product Code	Description	Width	Length	Material	Finish	Nominal Thickness / Gauge	Pcs/ Ctn	Lbs/ Ctn	Color Group
WV18H	18" W-Valley Hemmed	18"	10'	Aluminum	Acrylic	0.013	150	525	1
WV18S	18" W-Valley Galv Unhemmed	18"	10'	Galvanized Steel	Polyester	0.016	150	1260	1
WV18HS	18" W-Valley Hemmed Galv	18"	10'	Galvanized Steel	Polyester	0.016	150	1260	1
WV18HRS	18" W-Valley Hemmed Ribbed Galv	18"	10'	Galvanized Steel	Polyester	0.016	150	1260	1
WV20H	20" W-Valley Hemmed	20"	10'	Aluminum	Acrylic	0.013	150	585	1
WV20S	20" W-Valley Galv Unhemmed	20"	10'	Galvanized Steel	Polyester	0.016	150	1400	1
WV20HS	20" W-Valley Hemmed Galv	20"	10'	Galvanized Steel	Polyester	0.016	150	1400	1
WV20HRS	20" W-Valley Hemmed Ribbed Galv	20"	10'	Galvanized Steel	Polyester	0.016	150	1400	1
WV24H	24" W-Valley Hemmed	24"	10'	Aluminum	Acrylic	0.013	150	705	1
WV24S	24" W-Valley Galv Unhemmed	24"	10'	Galvanized Steel	Polyester	0.016	150	1680	1
WV24HS	24" W-Valley Hemmed Galv	24"	10'	Galvanized Steel	Polyester	0.016	150	1680	1
WV24HRS	24" W-Valley Hemmed Ribbed Galv	24"	10'	Galvanized Steel	Polyester	0.016	150	1680	1

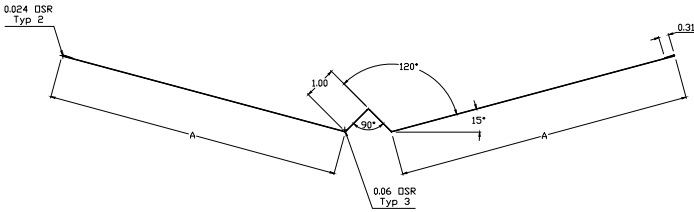

Color Group 0 | Mill, White/Black, Royal Brown/Terra Bronze

Color Group 1 | Mill, White, Black, Royal Brown, Terra Bronze

ROOFING ACCESSORIES

Roll Valley

Product Code	Description	Width	Length	Material	Finish	Nominal Thickness / Gauge	Pcs/ Ctn	Lbs/ Ctn	Color Group
RF2450	24"x50' Roll Flashing .013	24"	50'	Aluminum	Acrylic	0.013	1	17	0
RF2450S	24"x50' Roll Flashing Galv	24"	50'	Galvanized Steel	Polyester	0.016	1	56	0
RF2425	24"x25' Roll Flashing .013	24"	25'	Aluminum	Acrylic	0.013	1	9	0
RF2425S	24"x25' Roll Flashing Galv	24"	25'	Galvanized Steel	Polyester	0.016	1	28	0
RF2050	20"x50' Roll Flashing .013	20"	50'	Aluminum	Acrylic	0.013	1	14	0
RF2050S	20"x50' Roll Flashing Galv	20"	50'	Galvanized Steel	Polyester	0.016	1	46	0
RF2025	20"x25' Roll Flashing .013	20"	25'	Aluminum	Acrylic	0.013	1	7	0
RF2025S	20"x25' Roll Flashing Galv	20"	25'	Galvanized Steel	Polyester	0.016	1	23	0
RF1650	16"x50' Roll Flashing .013	16"	50'	Aluminum	Acrylic	0.013	1	12	0
RF1650S	16"x50' Roll Flashing Galv	16"	50'	Galvanized Steel	Polyester	0.016	1	37	0
RF1625	16"x25' Roll Flashing .013	16"	25'	Aluminum	Acrylic	0.013	1	6	0
RF1625S	16"x25' Roll Flashing Galv	16"	25'	Galvanized Steel	Polyester	0.016	1	19	0
RF1450	14"x50' Roll Flashing .013	14"	50'	Aluminum	Acrylic	0.013	1	10	0
RF1450S	14"x50' Roll Flashing Galv	14"	50'	Galvanized Steel	Polyester	0.016	1	33	0
RF1425	14"x25' Roll Flashing .013	14"	25'	Aluminum	Acrylic	0.013	1	5	0
RF1425S	14"x25' Roll Flashing Galv	14"	25'	Galvanized Steel	Polyester	0.016	1	16	0
RF1250	12"x50' Roll Flashing .013	12"	50'	Aluminum	Acrylic	0.013	1	9	0
RF1250S	12"x50' Roll Flashing Galv	12"	50'	Galvanized Steel	Polyester	0.016	1	28	0
RF1225	12"x25' Roll Flashing .013	12"	25'	Aluminum	Acrylic	0.013	1	4	0
RF1225S	12"x25' Roll Flashing Galv	12"	25'	Galvanized Steel	Polyester	0.016	1	14	0
RF1050	10"x50' Roll Flashing .013	10"	50'	Aluminum	Acrylic	0.013	1	7	0
RF1050S	10"x50' Roll Flashing Galv	10"	50'	Galvanized Steel	Polyester	0.016	1	23	0
RF1025	10"x25' Roll Flashing .013	10"	25'	Aluminum	Acrylic	0.013	1	4	0
RF1025S	10"x25' Roll Flashing Galv	10"	25'	Galvanized Steel	Polyester	0.016	1	12	0
RF850	8"x50' Roll Flashing .013	8"	50'	Aluminum	Acrylic	0.013	1	6	0
RF850S	8"x50' Roll Flashing Galv	8"	50'	Galvanized Steel	Polyester	0.016	1	19	0
RF825	8"x25' Roll Flashing .013	8"	25'	Aluminum	Acrylic	0.013	1	3	0
RF825S	8"x25' Roll Flashing Galv	8"	25'	Galvanized Steel	Polyester	0.016	1	9	0
RF650	6"x50' Roll Flashing .013	6"	50'	Aluminum	Acrylic	0.013	1	4	0
RF650S	6"x50' Roll Flashing Galv	6"	50'	Galvanized Steel	Polyester	0.016	1	14	0
RF625	6"x25' Roll Flashing .013	6"	25'	Aluminum	Acrylic	0.013	1	2	0
RF625S	6"x25' Roll Flashing Galv	6"	25'	Galvanized Steel	Polyester	0.016	1	7	0
RF450	4"x50' Roll Flashing .013	4"	50'	Aluminum	Acrylic	0.013	1	3	0
RF450S	4"x50' Roll Flashing Galv	4"	50'	Galvanized Steel	Polyester	0.016	1	9	0
RF425	4"x25' Roll Flashing .013	4"	25'	Aluminum	Acrylic	0.013	1	1	0
RF425S	4"x25' Roll Flashing Galv	4"	25'	Galvanized Steel	Polyester	0.016	1	5	0

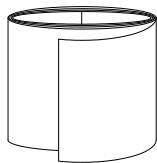

Color Group 0 | Mill, White/Black, Royal Brown/Terra Bronze
 Color Group 1 | Mill, White, Black, Royal Brown, Terra Bronze

PLY GEM STEEL SIDING

8" Woodgrain

Product Code: 8SWG

Description	Package
Coating: Textured, SMP	12 Pcs./Ctn.
Material: 28g G60 Steel	1 Sq./Ctn.
Length: 12' 6"	85 Lbs./Ctn.

Color Availability

White, Brandy Wood, Charcoal Grey, Dark Bronze, Deep Granite, Jefferson Tan, Mahogany Montana Suede, Natural Slate, Newport Bay, Pebblestone Clay, Quiet Willow, Red Brick Rugged Canyon, Terra Bronze, Wicker



THIS PRODUCT HAS BEEN GREEN APPROVED BY THE NABH RESEARCH CENTER. This means you can be assured that this product complies with specific green practice criteria in the National Green Building Standard. Visit www.GreenApprovedProducts.com for more details.

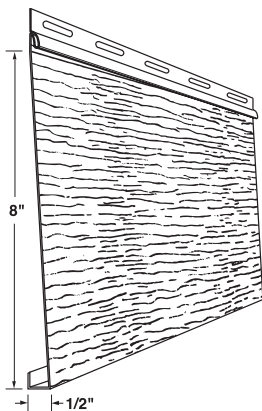

Double 4" Woodgrain

Product Code: D4SWG

Description	Package
Coating: Textured, SMP	12 Pcs./Ctn.
Material: 28g G60 Steel	1 Sq./Ctn.
Length: 12' 6"	91 Lbs./Ctn.

Color Availability

White, Brandy Wood, Charcoal Grey, Dark Bronze, Deep Granite, Jefferson Tan, Mahogany Montana Suede, Natural Slate, Newport Bay, Pebblestone Clay, Quiet Willow, Red Brick Rugged Canyon, Terra Bronze, Wicker



THIS PRODUCT HAS BEEN GREEN APPROVED BY THE NABH RESEARCH CENTER. This means you can be assured that this product complies with specific green practice criteria in the National Green Building Standard. Visit www.GreenApprovedProducts.com for more details.

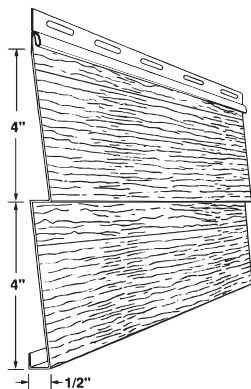

Double 5" Woodgrain

Product Code: D5SWG

Description	Package
Coating: Textured, SMP	10 Pcs./Ctn.
Material: 28g G60 Steel	1 Sq./Ctn.
Length: 12'	87 Lbs./Ctn.

Color Availability

- WHITE** White (04)
- LIGHT** Almond (53), Autumn Tan (M6), Beige (NB), Ivory (N3), Mist (NM), Olive (511), Pewter (NP), Sand (M4), Stone Gray (NS), Sunrise Yellow (IQ), Wicker (A7)
- CLASSIC** French Silk (210), Khaki (N4), Nantucket Gray (N8), Slate Blue (N1), Thistle (510)
- DEEP** Canyon (100), Granite (090), Wedgewood (390), Willow (170)



THIS PRODUCT HAS BEEN GREEN APPROVED BY THE NABH RESEARCH CENTER. This means you can be assured that this product complies with specific green practice criteria in the National Green Building Standard. Visit www.GreenApprovedProducts.com for more details.

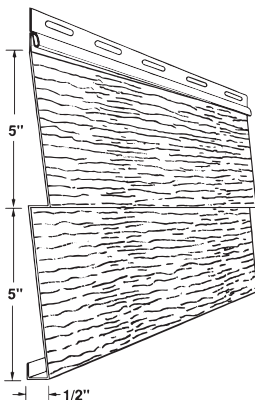

PLY GEM STEEL SIDING

Double 5" Dutch Lap Woodgrain

Product Code: **D5DLSWG**

Description

Coating: Textured, SMP
Material: 28g G60 Steel
Length: 12'

Package

10 Pcs./Ctn.
1 Sqs./Ctn.
87 Lbs./Ctn.

Color Availability

White, Brandy Wood, Charcoal Grey, Dark Bronze, Deep Granite, Jefferson Tan, Mahogany Montana Suede, Natural Slate, Newport Bay, Pebblestone Clay, Quiet Willow, Red Brick Rugged Canyon, Terra Bronze, Wicker



Home Innovation
NGBS GREEN CERTIFIED
RESOURCE EFFICIENCY

THIS PRODUCT HAS BEEN GREEN APPROVED BY THE NAHB RESEARCH CENTER.
This means you can be assured that this product complies with specific green practice criteria in the National Green Building Standard. Visit www.GreenApprovedProducts.com for more details.

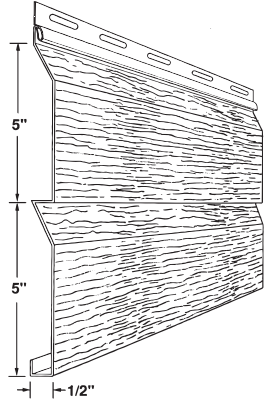

Board & Batten 10" Woodgrain

Product Code: **BB10SWG**

Description

Coating: Textured, SMP
Material: 28g G60 Steel
Length: 10'

Package

12 Pcs./Ctn.
1 Sqs./Ctn.
87 Lbs./Ctn.

Color Availability

White, Brandy Wood, Charcoal Grey, Dark Bronze, Deep Granite, Jefferson Tan, Mahogany Montana Suede, Natural Slate, Newport Bay, Pebblestone Clay, Quiet Willow, Red Brick Rugged Canyon, Terra Bronze, Wicker



Home Innovation
NGBS GREEN CERTIFIED
RESOURCE EFFICIENCY

THIS PRODUCT HAS BEEN GREEN APPROVED BY THE NAHB RESEARCH CENTER.
This means you can be assured that this product complies with specific green practice criteria in the National Green Building Standard. Visit www.GreenApprovedProducts.com for more details.

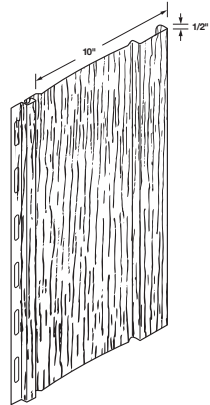

STEEL SIDING ACCESSORIES

Starter Strip

Product Code: **S1WAP**

Description	Package
Coating: Mill	40 Pcs./Ctn.
Material: 28g G60 Steel	55 Lbs./Ctn.

Color Availability

Mill Finish

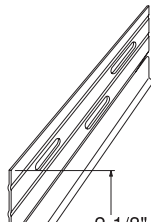

Outside Corner Post

Product Code: **OCPSWG**

Description	Package
Coating: Textured, SMP	10 Pcs./Ctn.
Material: 28g G60 Steel	67 Lbs./Ctn.
Length: 10'	

Color Availability

White, Almond, Brandy Wood, Cameo, Charcoal Grey, Dark Bronze, Deep Granite, Desert Sand, Jefferson Tan, Mahogany, Montana Suede, Musket Brown, Natural Slate, Newport Bay, Pebblestone Clay, Quiet Willow, Red Brick, Rugged Canyon, Terra Bronze, Wicker

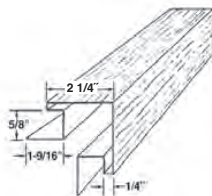

Smooth Outside Corner Post

Product Code: **OCPSSM**

Description	Package
Coating: Textured, SMP	10 Pcs./Ctn.
Material: 28g G60 Steel	67 Lbs./Ctn.
Length: 10'	

Color Availability

White, Brandy Wood, Charcoal Grey, Dark Bronze, Deep Granite, Jefferson Tan, Mahogany, Montana Suede, Natural Slate, Newport Bay, Pebblestone Clay, Quiet Willow, Red Brick, Rugged Canyon, Terra Bronze, Wicker

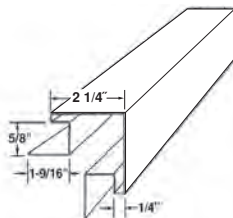

7/8" J Channel

Product Code: **78SJ**

Description	Package
Coating: Textured, SMP	25 Pcs./Ctn.
Finish: 28g G60 Steel	52 Lbs./Ctn.
Nominal: .019 Thick	
Length: 12'	

Color Availability

White, Brandy Wood, Charcoal Grey, Dark Bronze, Deep Granite, Jefferson Tan, Mahogany, Montana Suede, Natural Slate, Newport Bay, Pebblestone Clay, Quiet Willow, Red Brick, Rugged Canyon, Terra Bronze, Wicker

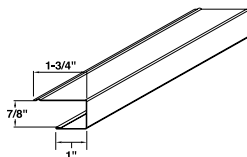

General Purpose Trim

Product Code: **UTS**

Description	Package
Coating: Textured, SMP	20 Pcs./Ctn.
Material: 28g G60 Steel	36 Lbs./Ctn.
Length: 12' 6"	

Color Availability

White, Brandy Wood, Charcoal Grey, Dark Bronze, Deep Granite, Jefferson Tan, Mahogany, Montana Suede, Natural Slate, Newport Bay, Pebblestone Clay, Quiet Willow, Red Brick, Rugged Canyon, Terra Bronze, Wicker

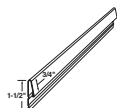

Trim Coil

Product Code: **STC2175**

Description

Coating: Textured, SMP
Material: 28g G60 Steel
Length: 50' x 21.75"

Package

24 Lbs./Ctn.

Color Availability

White, Almond, Brandy Wood, Cameo, Charcoal Grey, Classic Cream, Dark Bronze, Deep Granite, Desert Sand, Jefferson Tan, Mahogany, Montana Suede, Musket Brown, Natural Slate, Newport Bay, Pebblestone Clay, Quiet Willow, Red Brick, Royal Brown, Rugged Canyon, Sandtone, Stone Clay, Terra Bronze, Wicker



THIS PRODUCT HAS BEEN GREEN APPROVED BY THE NAHB RESEARCH CENTER.
This means you can be assured that this product complies with specific green practice criteria in the National Green Building Standard. Visit www.GreenApprovedProducts.com for more details.

10-5/8" Seamless Siding Coil

Product Code: **SC10625**

Description

Coating: Textured, SMP
Material: 28g G60 Steel
Width: 10.625"
Weight: 700lbs +/-70lbs

Package

Color Availability

White, Almond, Brandy Wood, Cameo, Charcoal Grey, Dark Bronze, Deep Granite, Desert Sand, Jefferson Tan, Mahogany, Montana Suede, Musket Brown, Natural Slate, Newport Bay, Pebblestone Clay, Quiet Willow, Red Brick, Rugged Canyon, Terra Bronze, Wicker



THIS PRODUCT HAS BEEN GREEN APPROVED BY THE NAHB RESEARCH CENTER.
This means you can be assured that this product complies with specific green practice criteria in the National Green Building Standard. Visit www.GreenApprovedProducts.com for more details.

13-1/4" Seamless Siding Coil

Product Code: **SC13250**

Description

Coating: Textured, SMP
Material: 28g G60 Steel
Width: 13.25"
Weight: 700lbs +/-70lbs

Package

Color Availability

White, Almond, Brandy Wood, Cameo, Charcoal Grey, Dark Bronze, Deep Granite, Desert Sand, Jefferson Tan, Mahogany, Montana Suede, Musket Brown, Natural Slate, Newport Bay, Pebblestone Clay, Quiet Willow, Red Brick, Rugged Canyon, Terra Bronze, Wicker



THIS PRODUCT HAS BEEN GREEN APPROVED BY THE NAHB RESEARCH CENTER.
This means you can be assured that this product complies with specific green practice criteria in the National Green Building Standard. Visit www.GreenApprovedProducts.com for more details.

Wood Grain Embossed 4" Fascia Trim

Product Code: F4SWG

Description	Package
Coating: Textured, SMP	20 Pcs./Ctn.
Material: 28g G60 Steel	55 Lbs./Ctn.
Length: 10'	

Color Availability

White, Dark Bronze, Musket Brown, Pebblestone Clay, Wicker

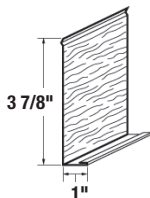

THIS PRODUCT HAS BEEN GREEN APPROVED BY THE NAHB RESEARCH CENTER. This means you can be assured that this product complies with specific green practice criteria in the National Green Building Standard. Visit www.GreenApprovedProducts.com for more details.

Wood Grain Embossed 6" Fascia Trim

Product Code: F6SWG

Description	Package
Coating: Textured, SMP	18 Pcs./Ctn.
Material: 28g G60 Steel	69 Lbs./Ctn.
Length: 10'	

Color Availability

White, Almond, Cameo, Charcoal Grey, Classic Cream, Dark Bronze, Desert Sand, Jefferson Tan, Montana Suede, Musket Brown, Pebblestone Clay, Quiet Willow, Royal Brown, Rugged Canyon, Sandtone, Stone Clay, Terra Bronze, Wicker

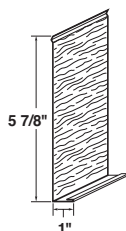

THIS PRODUCT HAS BEEN GREEN APPROVED BY THE NAHB RESEARCH CENTER. This means you can be assured that this product complies with specific green practice criteria in the National Green Building Standard. Visit www.GreenApprovedProducts.com for more details.

Wood Grain Embossed 8" Fascia Trim

Product Code: F8SWG

Description	Package
Coating: Textured, SMP	16 Pcs./Ctn.
Material: 28g G60 Steel	78 Lbs./Ctn.
Length: 10'	

Color Availability

White, Almond, Cameo, Charcoal Grey, Classic Cream, Dark Bronze, Desert Sand, Jefferson Tan, Montana Suede, Musket Brown, Pebblestone Clay, Quiet Willow, Royal Brown, Rugged Canyon, Sandtone, Stone Clay, Terra Bronze, Wicker



THIS PRODUCT HAS BEEN GREEN APPROVED BY THE NAHB RESEARCH CENTER. This means you can be assured that this product complies with specific green practice criteria in the National Green Building Standard. Visit www.GreenApprovedProducts.com for more details.

Envoy Wood Grain Embossed 10" Fascia Trim

Product Code: F10SWG

Description	Package
Coating: Textured, SMP	12 Pcs./Ctn.
Material: 28g G60 Steel	71 Lbs./Ctn.
Length: 10'	

Color Availability

White, Dark Bronze, Musket Brown, Pebblestone Clay, Wicker

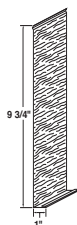

THIS PRODUCT HAS BEEN GREEN APPROVED BY THE NAHB RESEARCH CENTER. This means you can be assured that this product complies with specific green practice criteria in the National Green Building Standard. Visit www.GreenApprovedProducts.com for more details.



A beautiful home starts with **Cellwood.**

You can't go wrong when you start your next project with Cellwood siding and accessories. And because Cellwood is a part of Ply Gem, it's even easier for you to complete your project beautifully.

Ply Gem offers everything you need for your home exterior: siding, windows, stone veneer and fence and railing. All from leading brands in the Ply Gem family. All designed to work together to create a home you can be proud of.

For more information, visit [plygem.com](https://www.plygem.com)



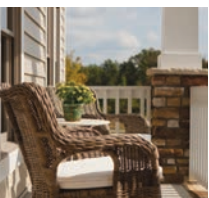

IF YOU KNOW CELLWOOD, YOU KNOW PLY GEM.

In addition to the vinyl, injection-molded and aluminum products you have come to trust, Ply Gem offers a full range of durable, low-maintenance exterior building products ideal for every project and budget.

Whether you need solutions for new construction or remodel and replacement, Ply Gem offers the solutions you are looking for.

- High-quality windows and doors from Ply Gem Windows and Great Lakes Window
- Attractive, durable stone veneer from Ply Gem Stone
- Low-maintenance products from Ply Gem Fence and Railing and Ply Gem Trim and Mouldings

You know our siding. Experience our other brands.

Build your future with us.

For more information,
visit [plygem.com](https://www.plygem.com)





THE PLY GEM PROMISE: Cellwood products are backed by Ply Gem — a 70-year leader in pioneering performance home exteriors, with a superior warranty for exactly the home you want for decades to come.

2600 Grand Blvd., Suite 900 | Kansas City, MO 64108 | 800-335-6701
cellwood.com



Ply Gem and Cellwood are trademarks of Ply Gem Industries, Inc. and/or its subsidiaries.

©2017 Cellwood 440108999113/BT/CG/1116

